



「
ENDURA
」

Low-rise elevators



MAKING CITIES BETTER

The world is changing, and our elevators are evolving with it. TK Elevator is at the forefront of urban mobility and solutions for rapid growth.

In addition to half of the global population, it has been predicted that another 2.8 billion people will reside in cities by 2050. As these cities and skylines rise to unreachable heights, the urgent need to provide sustainable options while adapting to new infrastructure developments is ever-present.

At TK Elevator, we strive to exceed expectations for residential and commercial buildings by offering elevators that reflect our pursuit of innovation. That's why we are proud to present our hydraulic elevator for low-rise buildings, endura.

Being the standard in reliability for over seven decades, endura is the perfect choice for any low-rise building. Customizable and sleek with a smooth performance, endura also gives peace of mind when it comes to sustainability. enviromax® fluid is 100% recyclable, 95% petroleum-free and available on all endura elevators.



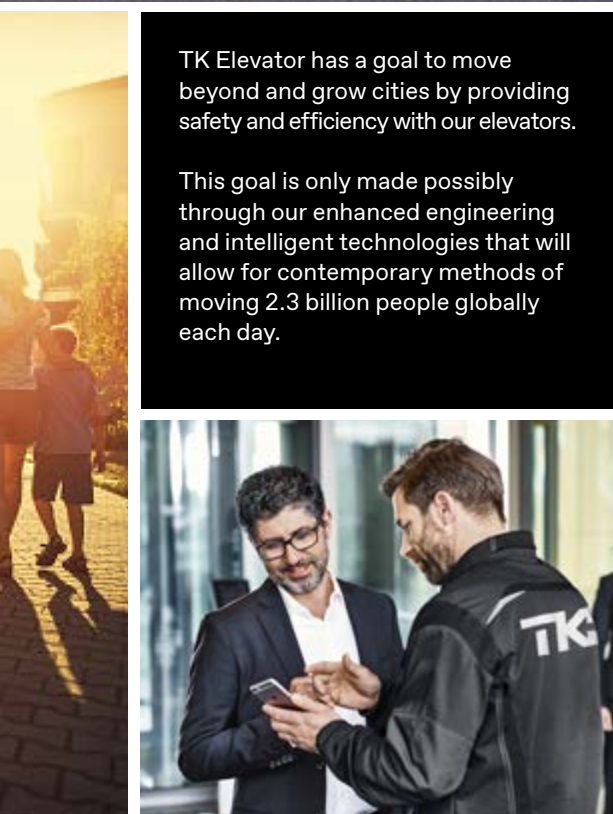

TK Elevator has a goal to move beyond and grow cities by providing safety and efficiency with our elevators.

This goal is only made possible through our enhanced engineering and intelligent technologies that will allow for contemporary methods of moving 2.3 billion people globally each day.

MAX: real-time predictive maintenance

CONTENTS

02

Making cities better 02

04

Engineering simplified for everyone 04

06

Choose endura 06

Machine room overview 06

Machine room-less overview 07

08

Simply more space 08

Smooth and reliable 10

12

Options

Steel shell 13

Applied Panels 15

Finishes 16

Cab accessory options 17

Fixtures 18

Entrance options 20

22

Planning 22

28

Our core values 28

ENGINEERING
SIMPLIFIED
FOR EVERYONE





Contractors

With endura, installation is easy. Our MRL application guarantees that there's less to build and manage as it removes the need for framing, electrical, HVAC, fireproof doors, and the locks and signage necessary for machine rooms.

You no longer have to provide disconnects and wiring chases, or assign coordination and installation tasks to partnering trades. Permanent power and a hoistway with a hoisting beam as well as required safety protection are all you need, and we do the rest.

Architects

There is no longer a need to worry about designing extra space for a machine room as endura is a machine-room less (MRL) application. The power unit is located in the elevator pit and the controller fits in the door jamb.

A machine room application is available for locations that require them or customers interested in a stronger lifting power.

With biodegradable fluid, endura is energy-efficient. This elevator that has reduced environmental impact also comes standard with LED lighting that lasts for years. Since the cab is from TK Elevator, it's the industry's only UL-validated, O1350 CA-compliant, low-emitting interior.



Building owners

This hydraulic elevator has fewer moving parts and lower maintenance costs than low-rise traction MRLs. It comes with MAX – our predictive maintenance solution that can lower elevator downtime by up to 50 percent. An electronic valve makes floor leveling adjustments automatically, decreasing unexpected service visits.

A battery-lowering operation (included with our MRL application) ensures tenants don't become trapped during a power failure. Nonproprietary user interface tools allow for unrestricted access for on-board adjusting and troubleshooting.

All this simplicity and reliability means fewer headaches for you — and your tenants.

CHOOSE ENDURA

endura is perfect for low-rise buildings.

Whether you want the architectural design freedom provided by machine room-less applications, or if you're in an area that requires a machine room — our hydraulic elevator has it all. Tenants will appreciate its smooth, quiet and reliable performance. The simplified design has fewer moving parts than traction MRL elevators. This means an easier installation and reduced maintenance costs.

Machine room application.

Offering smooth and quiet performance, our hydraulic elevator is ideal for small offices, shops, schools, apartments and worship facilities.

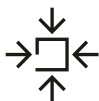

Fit
Machine Room



Travel
Up to 33'-6½" with
above-ground jack*
Up to 60'-0" with
below-ground jack





Machine room-less application.

With our MRL application, all equipment fits in the hoistway and you no longer need a machine room.

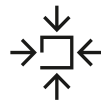

Fit
Machine room-less



Travel
Up to 33'-6½" with above-ground jack*

* with standard overhead and pit depth

SIMPLY MORE SPACE

Because our MRL application doesn't have a machine room, you have more leasable building space. Here are some of its key components.



Less elevator downtime with MAX
Our predictive maintenance solution, MAX, significantly reduces elevator downtime using Internet of Things (IoT) technology.

You get MAX with all endura applications.





1

Universal door operator

The new linear door operator technology provides enhanced door reliability as well as quick, smooth door operation. This reduces the number of service calls due to malfunctioning doors.



2

Disconnects

You no longer need to provide disconnects and wiring chases, or assign coordination and installation tasks to partnering trades. Permanent power and a hoistway are all you need to provide.



3

Controller

Fits into a tiny 8½-inch wall and is fully digital. This saves space and helps reduce elevator noise.

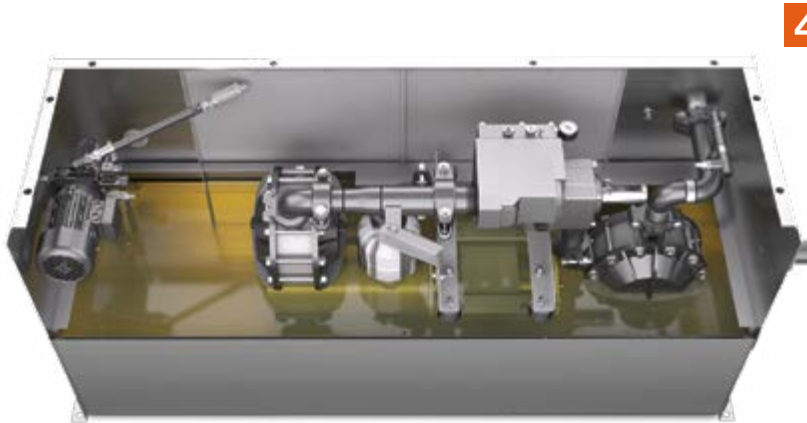

4

Power unit

The power unit, located in the pit, is designed to reduce noise in the hoistway. It's sealed with a hardtop and sound-deadening material. Inside, the submersible design and dual muffler devices ensure a quiet ride.

It also features a new electronic valve. The valve is virtually adjustment-free and allows for improved leveling accuracy.



5

Jack unit (holeless design)

Our MRL application uses a holeless jack that requires no drilling.

SMOOTH AND RELIABLE

In our machine room application, the power unit and controller are located outside the hoistway. You'll choose from four applications based on required travel distance and project site conditions. All options are configurable to any building design.





Universal door operator

It's all about the doors. This new linear door operator technology improves elevator door reliability while providing a quick and smooth door operation.



Jack unit

Our telescopic above-ground and below-ground conventional holed jacks provide a smooth elevator ride along with accurate leveling.



Controller

Our powerful 32-bit microprocessor controller uses solid-state technology, boosting reliability. The mounted user interface tool (UIT) provides easy access to adjustments and parameters for maintenance and service.

Maintenance costs are reduced because of non-proprietary equipment, fewer testing requirements and fewer components.

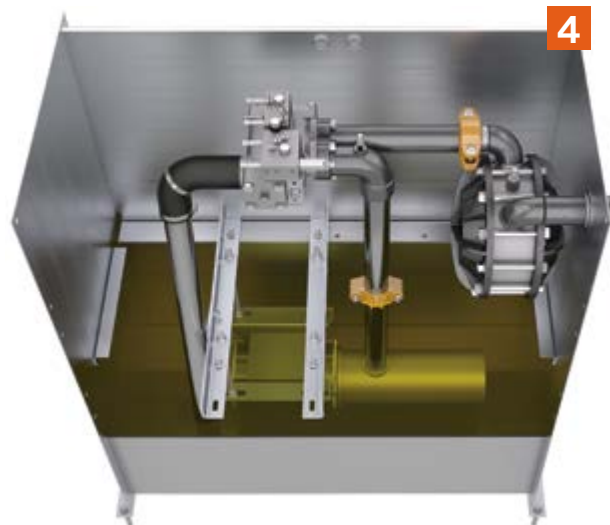

Power unit

Enables smooth stops and starts along with precise leveling. You'll appreciate the low maintenance requirements.



SIMPLE YET SOPHISTICATED

We offer you choices, whether you need vandal-resistant durability or want to retain a sleek polished interior. Available in many colors.

Pictured above: Brushed stainless steel wall finish with suspended ceiling. Floors by others.

Steel shell

Standard cab designs



Steel shell wall design

Clean and modern flat cab interior designs convey quality. Our durable formed steel shell cab is available in a variety of powder coat options or can be upgraded to stainless steel.

Wall finish options

Powder coats



Base finish options

Powder coats





VERTICAL APPLIED PANELS

Our cab and finish options let you personalize your elevator interior. Just like you want to.

Pictured above: Graystone plastic laminate vertical applied panels with downlight ceiling.

Floors by others.

Applied panels

Upgraded cab



Steel shell wall with applied panel design

Mix beauty and practicality with this decorative and durable cab. The panel design is constructed with a high-quality steel shell and vertical raised panels made with a core of urea formaldehyde-free particle board.

Panel finish options

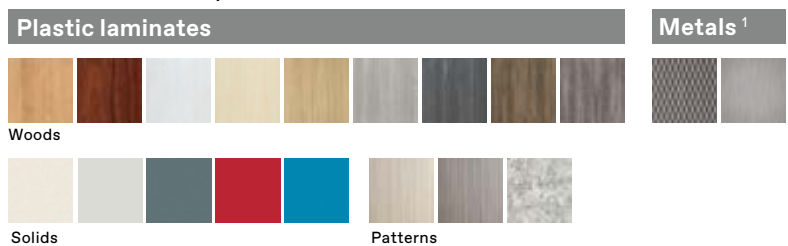

Reveal, base, frieze finish options



¹ Contact your local representative for detailed availability on our metal options.

Finishes

Plastic laminates

Woods

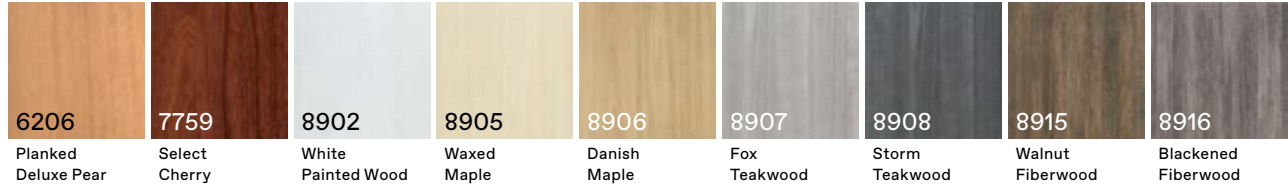

Solids

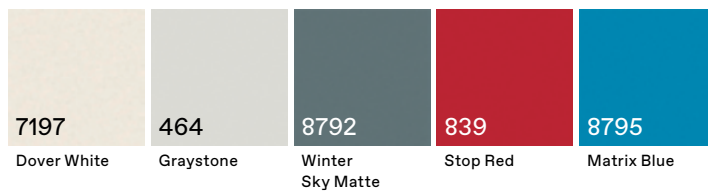

Patterns

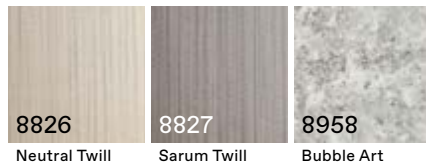

Powder Coats



Metals

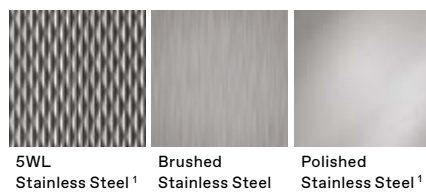

¹ Limited application. Contact your local representative for details.

 Colors may vary. We recommend examining a large color selector sheet before making a selection.

Cab accessory options



Braille plates

- Option 1:** Resin braille plate
- Option 2:** Surface mount cast braille plate
- Option 3:** Flush (inlaid) mount cast braille plate



Sills

Our cab sill finishes allow you to match your sills to any other design component inside the cab.



Aluminum



Nickel Silver

Ceilings



Basic flat ¹

Exposed cab top with optional recessed lighting.



Suspended

White translucent diffusers with ceiling frames.



Downlight ²

Metal pan downlight ceiling features LED lighting with six or nine lights (based on cab size.)

Handrails

Cylindrical

1½" cylindrical handrail



Flat bar

Metal bar handrail is available in 2", 4" or 6" widths.



Illustrations vary based on configurations. ¹ Not available on all models. ² Lighting options may vary depending on cab size.

Fixtures

Traditional fixtures

Product details

- Faceplates in brushed or polished stainless steel
- Position indicator displays car location with matrix of red or blue LED-illuminated dots



Combo hall lantern and position indicator with directional arrows



Intermediate hall lantern with arrows



Intermediate hall station



Intermediate hall station with fire services devices

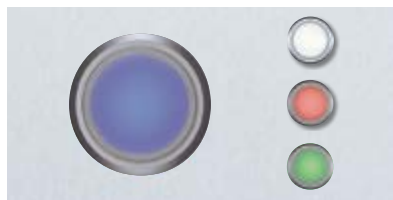

Push button available in blue, white, red and green LED lighting



Car operating panel

Vandal-resistant fixtures

Product details

- Faceplates in brushed or polished stainless steel
- Metal push buttons and durable car riding lanterns
- Pry-resistant hall jamb symbols and buttons
- Position indicator displays car location with matrix of red or blue LED-illuminated dots



Combo hall lantern and position indicator with directional arrows



Intermediate hall lantern with arrows



Terminal hall station



Intermediate hall station with fire services devices



Push button available in red, blue, white and green LED lighting



Car operating panel



Fixtures shown above are for representation only. Your project-specific application may vary.

Door configurations

Door orientation options offer a range of benefits to accommodate different project needs.

One-speed The most economical door offering, available with either right- or left-hand opening. (right-hand shown)

Two-speed Provides a wider opening without compromising door cycling time. Two doors move in the same direction, one sliding faster than the other. Available with either right- or left-hand opening. (right-hand shown)

Center opening Best for high-traffic buildings. Permits the quickest entry and exit, improving elevator service while giving an attractive, symmetrical appearance.

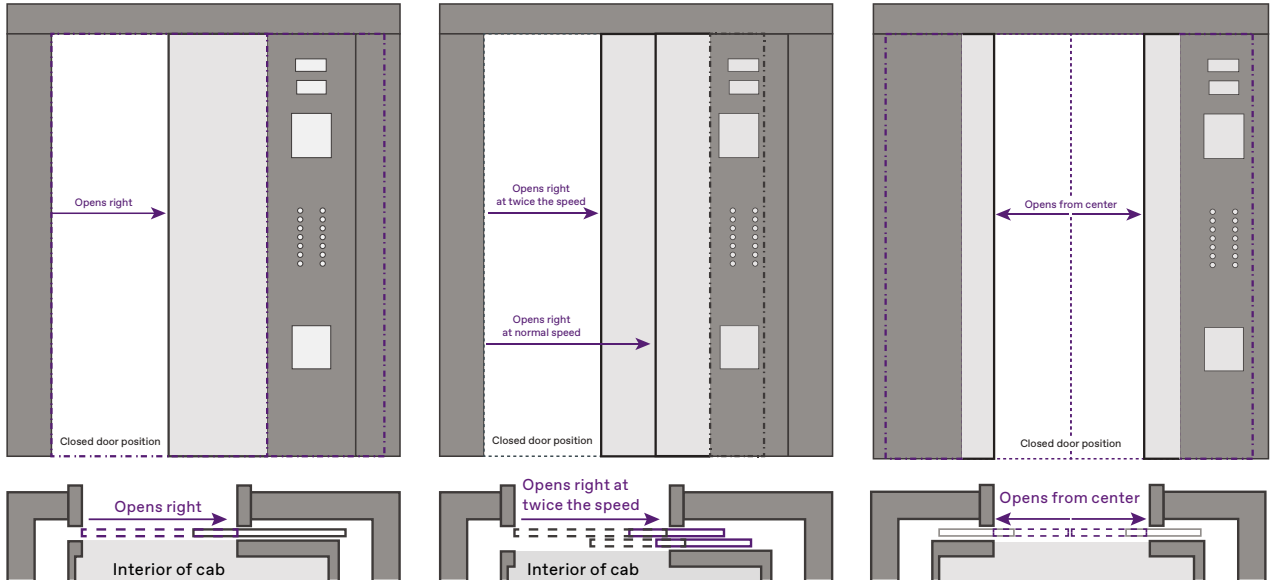

Front returns



Column returns
This return features a hinged car operating panel secured to the filler panel and aligned vertically with the column.

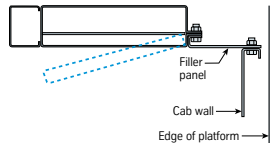

Wrap-around returns*
This return features a hinged car operating panel and separate filler panel. Comes standard.

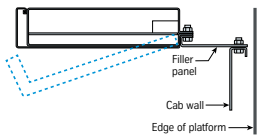

Front returns include the car station, return panel, signal fixtures and head jamb.

Images above represent return types in brushed stainless steel.
* Comes standard

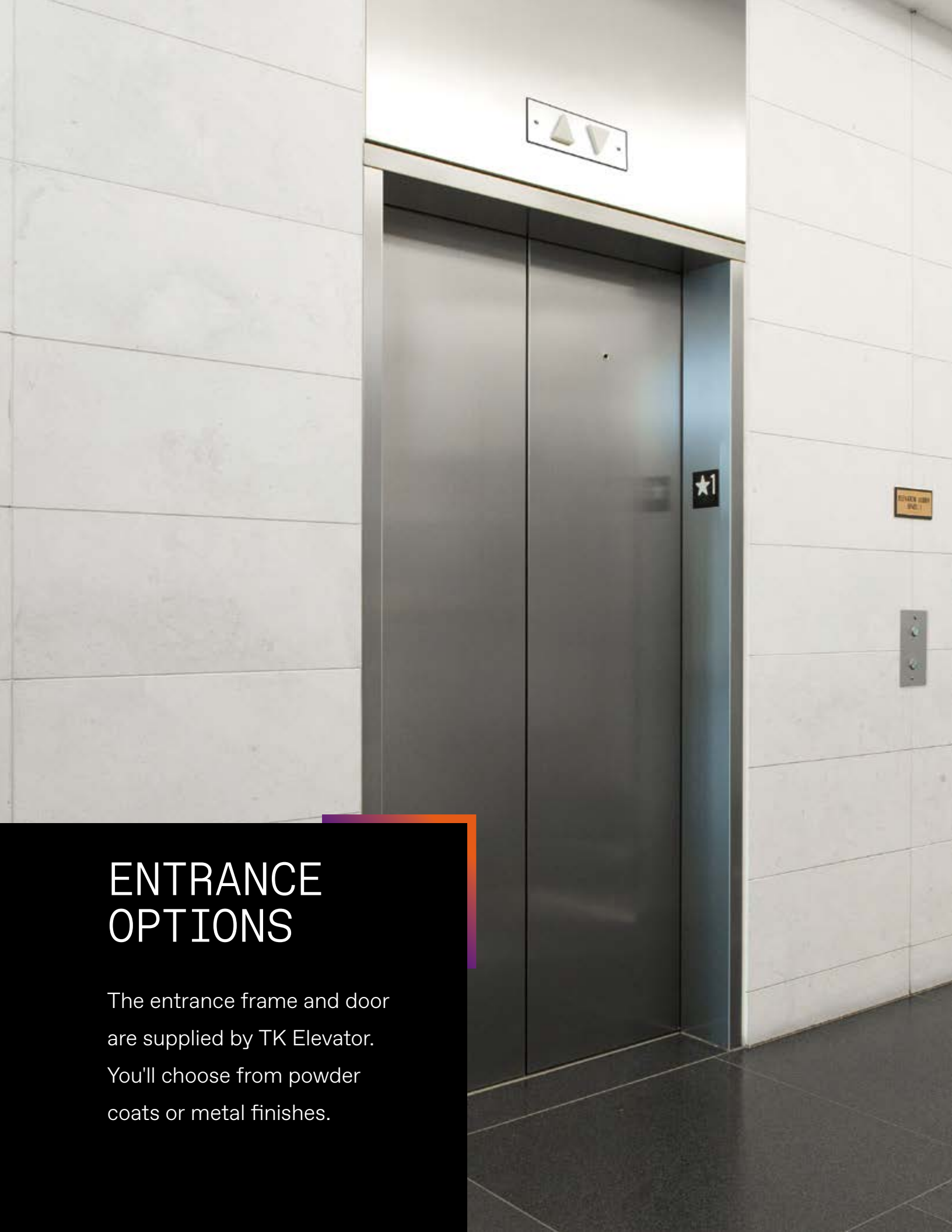

ENTRANCE OPTIONS

The entrance frame and door are supplied by TK Elevator. You'll choose from powder coats or metal finishes.

Entrance finishes

Hoistway and door entrance finishes

Typically, the entrance frame would match the door selection, but nothing says you have to. Choose from a limited selection of powder coat color or brushed stainless steel finish.



Powder coat finish
T-style entrance frame in Chalk Board powder coat.



Metal finish
T-style entrance frame in Brushed Stainless Steel.

Powder coats

Metals

			Contact your local representative for detailed availability on our metal options.
--	--	--	---

Hoistway entrance frame

Face of frame is a standard two inches.

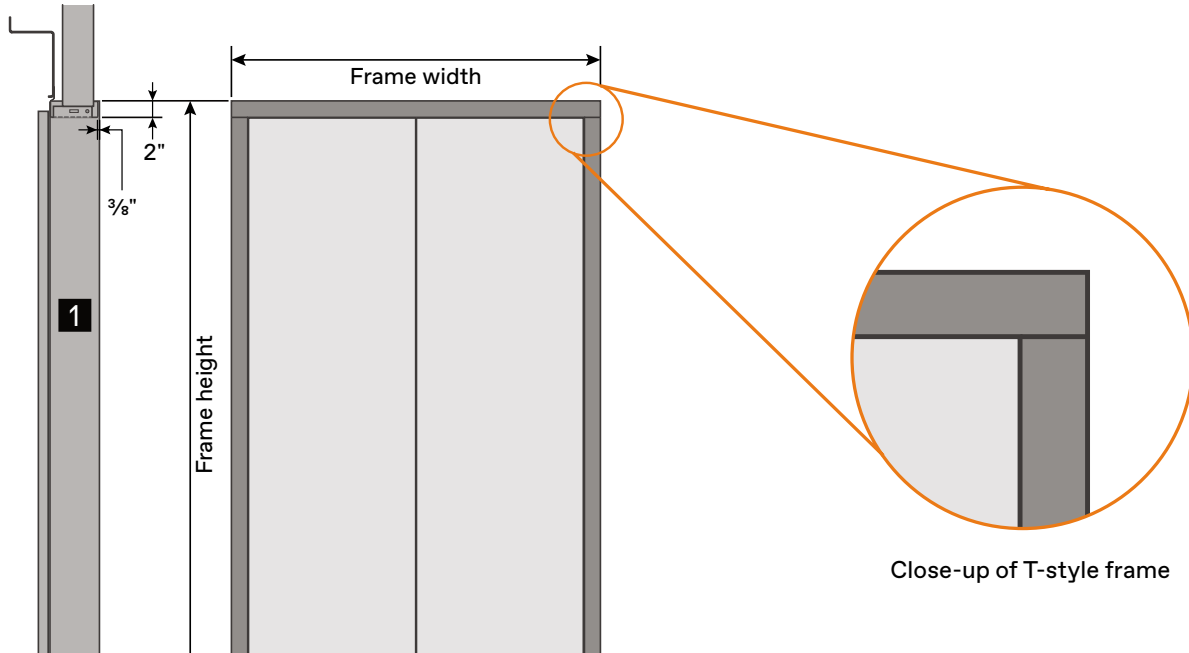

PLANNING

Above-ground jack applications



Machine room-less



Machine room

The numbers at a glance



Type
Above-ground jack



Travel
Up to 33'-6½"



Capacity
2100 - 5000 lbs



Speed
80 - 150 fpm

Holeless above-ground technical specifications

Speeds in fpm	80, 100, 110, 125, 150 feet per minute (dependent on project-specific conditions, such as capacity, machine room location, etc.)
Maximum travel	33'-6½" with standard overhead and pit depth; serves up to six floors with additional pit and overhead
Jack types	Single, Two-stage, Three-stage (telescoping)
Power characteristics	200-480 VAC, 3 phase, 60 hertz; (single-phase application is available as an option)
Controller	TAC32
Door operator	Universal Door Operator
Manual lowering	Standard
Battery-lowering operation	Standard on machine room-less application. Available as an option on machine room application.

Below-ground jack applications



The numbers at a glance



Type
Below-ground jack



Travel
Up to 60'-0"



Capacity
2100 – 5000 lbs



Speed
80 – 200 fpm

Holed below-ground technical specifications

Speeds (fpm)	80, 100, 110, 125, 150, 175, 200 feet per minute
Maximum travel	Below-ground jack: 60'-0"
Jack types	Below-ground: conventional
Power Characteristics	200-480 VAC, 3 phase, 60 hertz; (single-phase application is available as an option)
Controller	TAC32
Door Operator	Universal Door Operator
Manual Lowering	Standard
Battery-lowering operation	Available as an option

endura

Passenger elevators - twinpost above-ground

Side view
Front opening

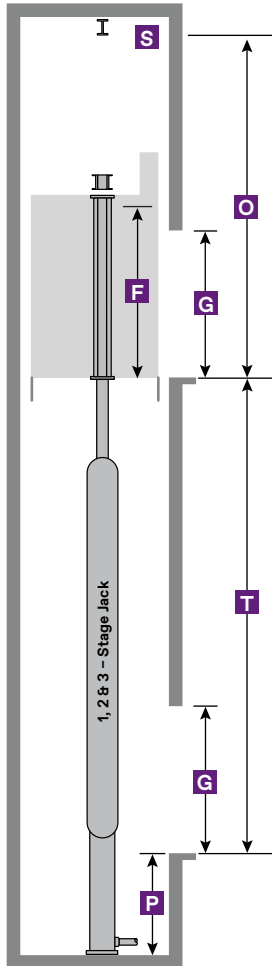

Side view
Front and rear opening

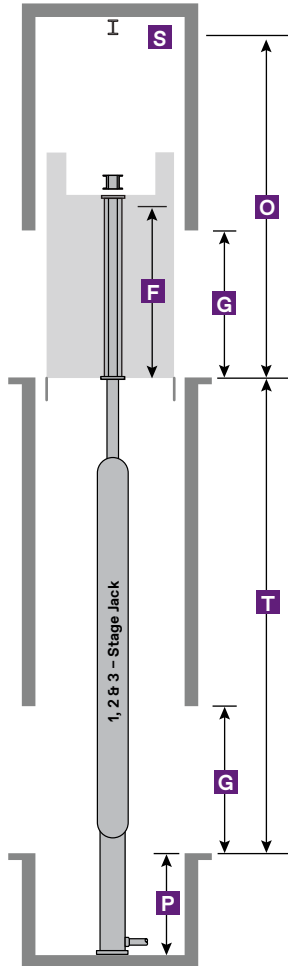

- A** Hoistway width
- B** Hoistway depth
- C** Inside clear width
- D** Inside clear depth
- E** Door clear width
- F** Inside clear height
- G** Door clear height
- O** Minimum overhead
- P** Minimum pit depth
- S** Safety beam
- T** Travel

One-speed center opening doors

Top view:
Front opening

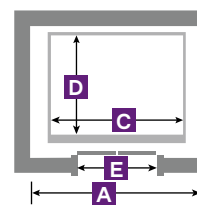

Top view:
Front and rear opening

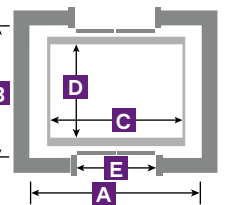

One-speed side opening doors

Top view:
Front opening

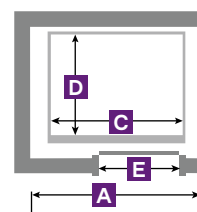

Top view:
Front and rear opening

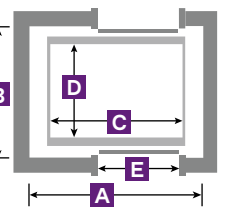

F Inside clear height: 7'-4"⁵

G Door clear height: 7'-0"

O Minimum overhead:

Up to 100 fpm:	Over 100 fpm:
1-Stage - 12'-2"	1-Stage - 12'-5"
2-Stage - 12'-8"	2-Stage - 12'-8"
3-Stage - 12'-11"	3-Stage - 12'-11"

P Minimum pit depth: 4'-0"⁶

T Max travel possible:¹
1-Stage: Up to 100 fpm - 18'-11"
 Over 100 fpm - 18'-8"
2-Stage: 28'-6"
3-Stage: 48'-3½"

S Safety beam required per OSHA 1926.502⁷

Passenger elevator

Capacity (lbs)	1-and 2-Stage Hoistway ^{2,9} A x B	3-stage Hoistway ⁹ A x B	Front / rear	Inside clear C x D	Door type	Door width E
2100 ³	7'-4" x 5'-9"	7'-8" x 5'-9"	F	5'-8" x 4'-3"	One-speed	3'-0"
2100 ³	7'-4" x 6'-8¾"	7'-8" x 6'-8¾"	F/R	5'-8" x 4'-3½"	One-speed	3'-0"
2500	8'-4" x 5'-9"	8'-8" x 5'-9"	F	6'-8" x 4'-3"	One-speed	3'-6"
2500 ⁴	8'-4" x 6'-8¾"	8'-8" x 6'-8¾"	F/R	6'-8" x 4'-3½"	One-speed	3'-6"
3000 ⁴	8'-4" x 6'-3"	8'-8" x 6'-3"	F	6'-8" x 4'-9"	One-speed	3'-6"
3000 ⁴	8'-4" x 7'-2¾"	8'-8" x 7'-2¾"	F/R	6'-8" x 4'-9½"	One-speed	3'-6"
3500 ⁴	8'-4" x 6'-11"	8'-8" x 6'-11"	F	6'-8" x 5'-5"	One-speed	3'-6"
3500 ⁴	8'-4" x 7'-10¾"	8'-8" x 7'-10¾"	F/R	6'-8" x 5'-5½"	One-speed	3'-6"
4000 ⁴	9'-4" x 6'-11"	9'-8" x 6'-11"	F	7'-8" x 5'-5"	One-speed	3'-6"/4'-0"
4000 ⁴	9'-4" x 7'-10¾"	9'-8" x 7'-10¾"	F/R	7'-8" x 5'-5½"	One-speed	3'-6"/4'-0"

Contact your local representative for various code or jurisdictional exceptions, or alterations required.

See endnotes on page 29.

endura

Service elevators – twinpost above-ground

Side view
Front opening

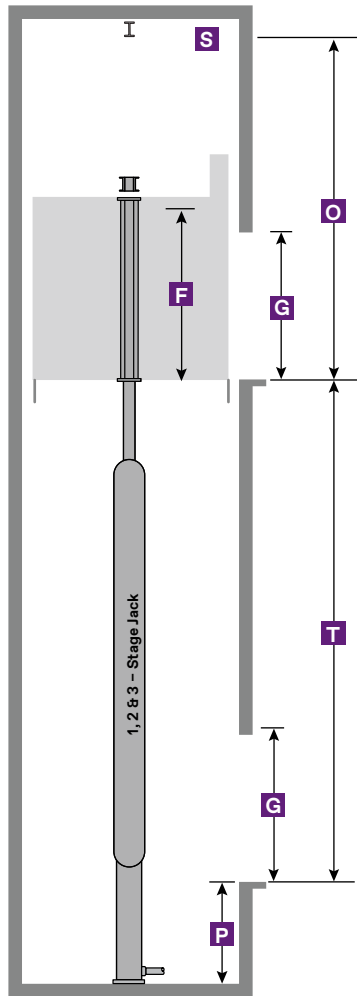

Side view
Front and rear opening

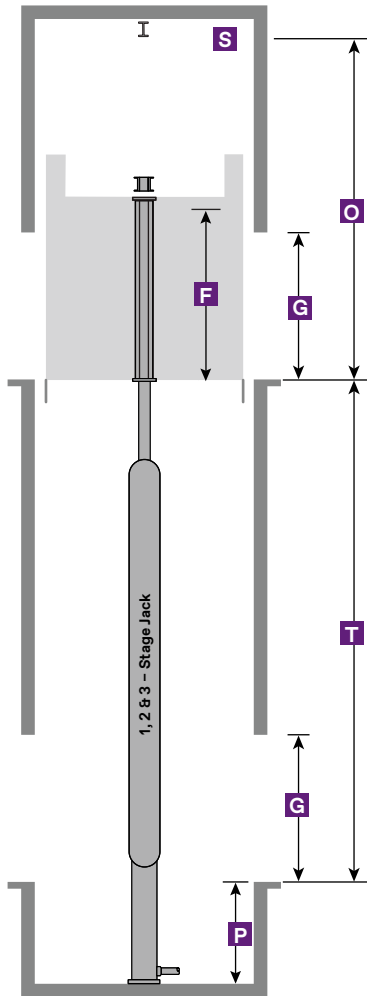

- A** Hoistway width
- B** Hoistway depth
- C** Inside clear width
- D** Inside clear depth
- E** Door clear width
- F** Inside clear height
- G** Door clear height
- O** Minimum overhead
- P** Minimum pit depth
- S** Safety beam
- T** Travel

Two-speed side opening doors

Top view:
Front opening

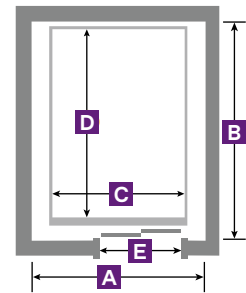

Top view:
Front and rear opening

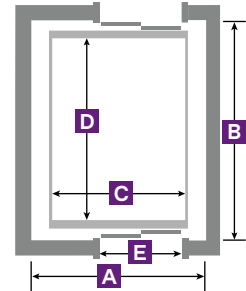

- F** Inside clear height: 7'-4"⁵
- G** Door clear height: 7'-0"
- O** Minimum overhead:

Up to 100 fpm:	Over 100 fpm:
1-Stage – 12'-2"	1-Stage – 12'-5"
2-Stage – 12'-8"	2-Stage – 12'-8"
3-Stage – 12'-11"	3-Stage – 12'-11"

P Minimum pit depth: 4'-0"⁶

T Max travel possible:¹
 1-Stage: Up to 100 fpm – 18'-11"
 Over 100 fpm – 18'-8"
 2-Stage: 28'-6"
 3-Stage: 48'-3½"

S Safety beam required per OSHA 1926.502⁷

Service 1-and 2-Stage 3-Stage

Capacity (lbs)	Hoistway ^{2,8,9} A x B	Hoistway ^{8,9} A x B	Front/rear	Inside clear C x D	Door type	Door width ⁸ E
4500	7'-4" x 9'-6½"	7'-8" x 9'-6½"	F	5'-8" x 7'-9½"	Two-speed	4'-0"/4'-6"
4500	7'-4" x 10'-9¼"	7'-8" x 10'-9¼"	F/R	5'-8" x 7'-10"	Two-speed	4'-0"/4'-6"
5000	7'-4" x 10'-2"	7'-8" x 10'-2"	F	5'-8" x 8'-5"	Two-speed	4'-0"/4'-6"
5000	7'-4" x 11'-4¾"	7'-8" x 11'-4¾"	F/R	5'-8" x 8'-5½"	Two-speed	4'-0"/4'-6"
5000H	7'-4" x 10'-9"	7'-8" x 10'-9"	F	5'-8" x 9'-0"	Two-speed	4'-0"/4'-6"
5000H	7'-4" x 11'-11¼"	7'-8" x 11'-11¼"	F/R	5'-8" x 9'-0½"	Two-speed	4'-0"/4'-6"

Contact your local representative for various code or jurisdictional exceptions, or alterations required.

See endnotes on page 29.

endura

Passenger elevators - below-ground

Side view
Front opening

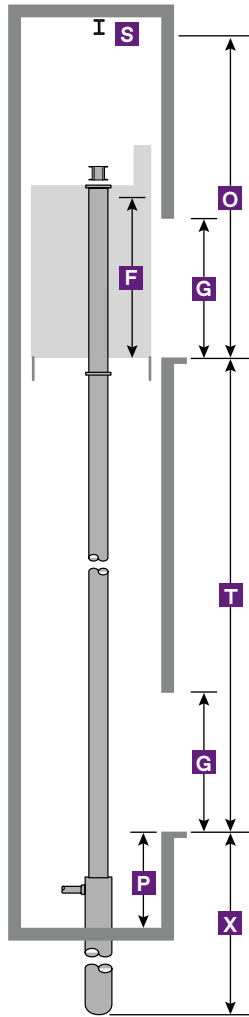

Side view
Front and rear opening

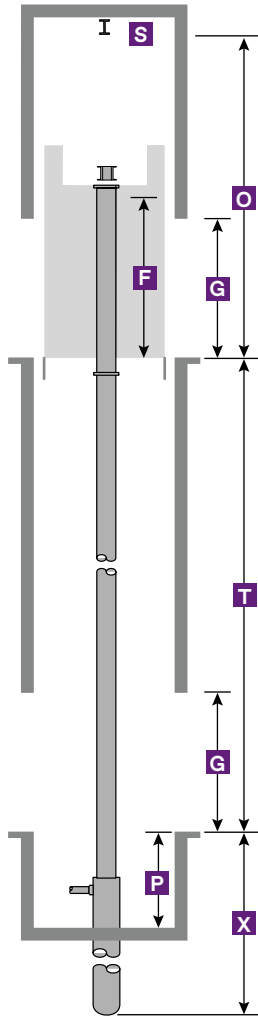

- A** Hoistway width
- B** Hoistway depth
- C** Inside clear width
- D** Inside clear depth
- E** Door clear width
- F** Inside clear height
- G** Door clear height
- O** Minimum overhead
- P** Minimum pit depth
- S** Safety beam
- T** Travel
- X** Jack hole depth

One-speed center opening doors

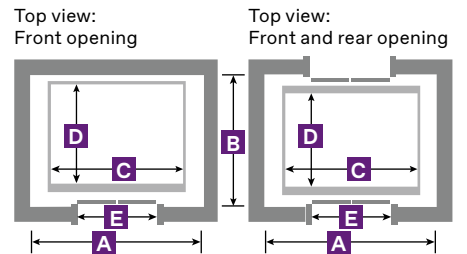

One-speed side opening doors

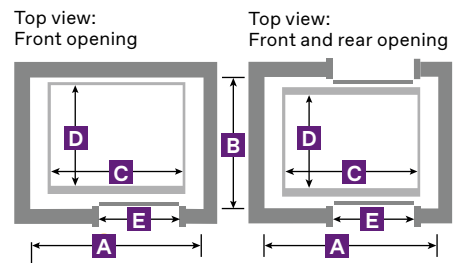

- F** Inside clear height: 7'-4"⁵
- G** Door clear height: 7'-0"
- O** Minimum overhead:
Up to 100 fpm – 12'-0"
Over 100 fpm – 12'-3"
- P** Minimum pit depth: 4'-0"⁶

S Safety beam required per OSHA 1926.502⁷

T Max travel possible: 60'-0"

X Standard jack hole depth:
Travel + 6'-0"

Contact your local representative for various code or jurisdictional exceptions, or alterations required.

See endnotes on page 29.

Passenger					
Capacity (lbs)	Hoistway ^{2,9} A x B	Front/rear	Inside clear C x D	Door type	Door width E
2100 ³	7'-4" x 5'-9"	F	5'-8" x 4'-3"	One-speed	3'-0"
2100 ³	7'-4" x 6'-8¾"	F/R	5'-8" x 4'-3½"	One-speed	3'-0"
2500	8'-4" x 5'-9"	F	6'-8" x 4'-3"	One-speed	3'-6"
2500 ⁴	8'-4" x 6'-8¾"	F/R	6'-8" x 4'-3½"	One-speed	3'-6"
3000 ⁴	8'-4" x 6'-3"	F	6'-8" x 4'-9"	One-speed	3'-6"
3000 ⁴	8'-4" x 7'-2¾"	F/R	6'-8" x 4'-9½"	One-speed	3'-6"
3500 ⁴	8'-4" x 6'-11"	F	6'-8" x 5'-5"	One-speed	3'-6"
3500 ⁴	8'-4" x 7'-10¾"	F/R	6'-8" x 5'-5½"	One-speed	3'-6"
4000 ⁴	9'-4" x 6'-11"	F	7'-8" x 5'-5"	One-speed	3'-6"/4'-0"
4000 ⁴	9'-4" x 7'-10¾"	F/R	7'-8" x 5'-5½"	One-speed	3'-6"/4'-0"

endura

Service elevators – below-ground

Side view
Front opening

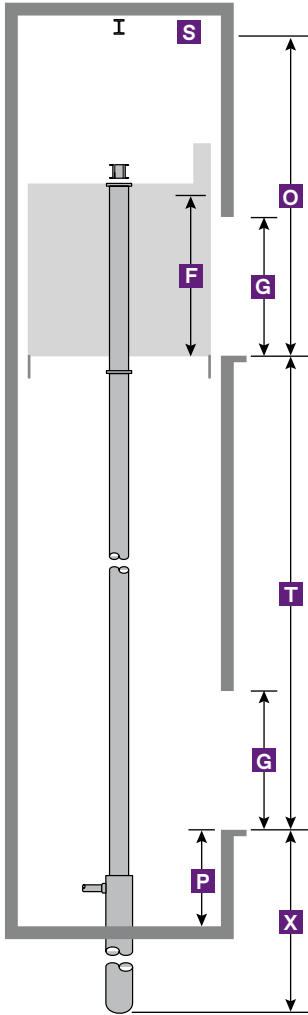

Side view
Front and rear opening

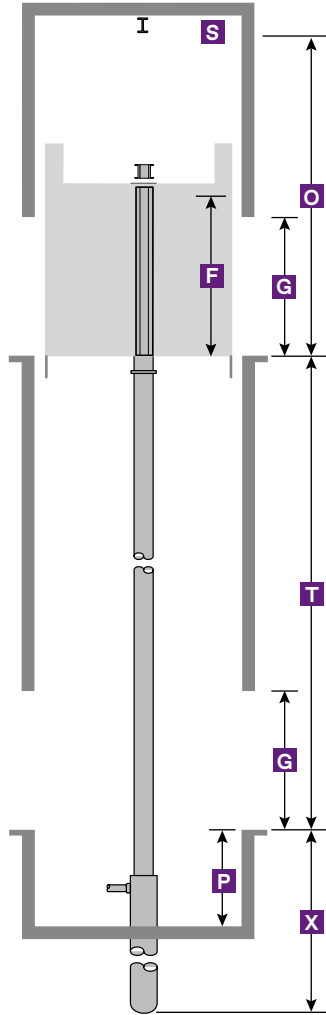

- A** Hoistway width
- B** Hoistway depth
- C** Inside clear width
- D** Inside clear depth
- E** Door clear width
- F** Inside clear height
- G** Door clear height
- O** Minimum overhead
- P** Minimum pit depth
- S** Safety beam
- T** Travel
- X** Jack hole depth

Two-speed side opening doors

Top view:
Front opening

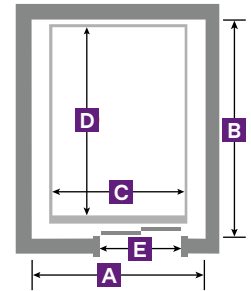

Top view:
Front and
rear opening

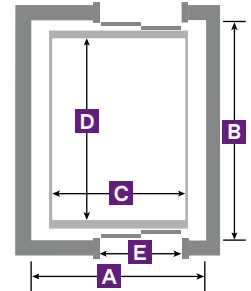

- F** Inside clear height: 7'-4"⁵
- G** Door clear height: 7'-0"
- O** Minimum overhead:
Up to 100 fpm – 12'-0"
Over 100 fpm – 12'-3"

- P** Minimum pit depth: 4'-0"⁶

- S** Safety beam required per OSHA 1926.502⁷

- T** Max travel possible: 60'-0"

- X** Standard jack hole depth:
Travel + 6'-0"

Service

Capacity (lbs)	Hoistway ^{2,8,9} A x B	Front/rear	Inside clear C x D	Door type	Door width ⁸ E
4500	7'-4" x 9'-6½"	F	5'-8" x 7'-9½"	Two-speed	4'-0"/4'-6"
4500	7'-4" x 10'-9¼"	F/R	5'-8" x 7'-10"	Two-speed	4'-0"/4'-6"
5000	7'-4" x 10'-2"	F	5'-8" x 8'-5"	Two-speed	4'-0"/4'-6"
5000	7'-4" x 11'-4¾"	F/R	5'-8" x 8'-5½"	Two-speed	4'-0"/4'-6"
5000H	7'-4" x 10'-9"	F	5'-8" x 9'-0"	Two-speed	4'-0"/4'-6"
5000H	7'-4" x 11'-11¼"	F/R	5'-8" x 9'-0½"	Two-speed	4'-0"/4'-6"

Contact your local representative for various code or jurisdictional exceptions, or alterations required.

See endnotes on page 29.

endura MRL controllers



Our endura MRL maximizes space because the controller is in the entrance jamb.

A minimum 8½-inch wall thickness is required at the floor the controller is located. The controller must be located at the landing directly above the lowest landing served by the elevator.

If that's not possible, the location must be coordinated with your TK Elevator representative.

Controller installation

The wall construction can be done with drywall or masonry block. For installation purposes, however, the entire wall at the controller level must be left out until the elevator frame and controller are in place.

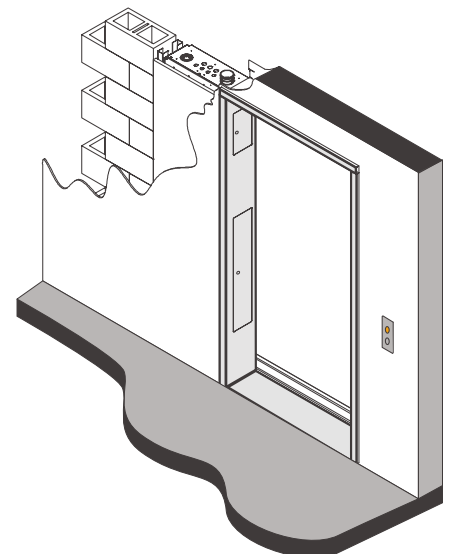

Perspective view

endura with machine room

Your endura MR system determines the machine room you'll need.

The most desirable machine room location is on the lowest floor served, next to the elevator hoistway. At an additional cost, the machine room can be located remotely from hoistway.

Smaller or custom-sized machine rooms are available in some cases. Contact your TK Elevator representative to help determine your needs, as machine room arrangements may vary from those shown.



Single car					
Power unit	A	B	C ¹⁰	Door height	Room height
Submersible (large)	7'-2"	7'-1½"	4'-0"	Min 7'-0"	Min 7'-6"
Dry (large)	9'-10"	5'-6"	4'-0"	Min 7'-0"	Min 7'-6"

Dual car					
Power unit	D	E	F ¹⁰	Door height	Room height
Submersible (large)	10'-5½"	10'-5½"	4'-0"	Min 7'-0"	Min 7'-6"
Dry (large)	14'-7"	7'-0¾"	4'-0"	Min 7'-0"	Min 7'-6"

Single-car configurations

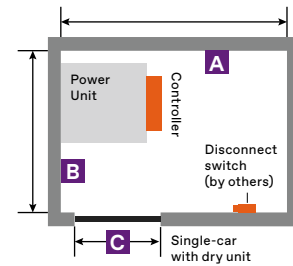

Dual-car configurations

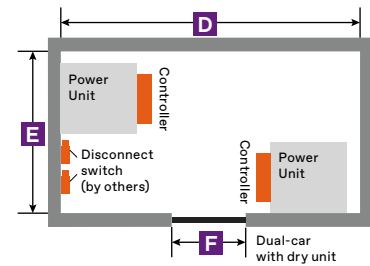

Endnotes

Dimensional data shown is for both seismic and nonseismic conditions and complies with current ASME A17.1 and CSA B44 Safety Code for Elevators. Local codes may vary from the national codes. Consult your TK Elevator representative for details.

¹ A 5'-0" min. pit is required for additional travel. Travel above 12'-8" (1-Stage) or 23'-2½" (2-Stage) or 33'-6½" (3-Stage) requires additional pit and/or overhead by adding 1" for every 1" (1-Stage) or 2" (2-Stage) or 3" (3-Stage) of additional travel. Max increase 2'-0" allowed in overhead. Max travel can be limited by gross load on jack. Local codes may impact pit depth minimum that will affect extended travel. Contact your local representative for max and min travel details.

² In areas where a 7" deep pit ladder is required, additional hoistway width or wall pocket will be required.

³ This capacity is not available with center opening doors.

⁴ To meet the requirements of IBC code for 84" stretchers, a 4'-0" center opening (for 4000 lbs capacity only) or 3'-6" side opening (for 3500 lbs or 4000 lbs capacity) door is required. If a smaller capacity car needs to be the stretcher capable car, contact your local representative for more information.

⁵ Dimension shown is based on suspended ceiling design. An increase in cab height will result in an increase in overhead requirements. For above-ground, front and rear opening applications, the cab height is limited to 7'-4".

⁶ Local codes may impact pit depth minimums.

⁷ Provided and installed by others, as directed by your TK Elevator representative. Clear overhead is shown to the bottom of the safety beam.

⁸ For service cars (4500 and 5000 lbs capacity) with optional 4'-6" two-speed side opening door, the hoistway width becomes 8'-2" for below-ground and 1- and 2-stage above-ground jack types and increases to 8'-4" for a 3-stage above-ground jack type. The hoistway width must increase an additional 10" if front and rear configuration with the same hand doors (catty-corner) are used.

⁹ For multiple elevators: Add 4" for a divider beam between hoistways.

¹⁰ Clear opening

Illustrations and images in this brochure may differ from the installed product. Consult your local representative for more information.



Our core principles



YOUR INNOVATION PARTNER

elevators and escalators under maintenance

countries of customers

1,500,000 100+

employees

50,000+

service available for customers

locations

24/7 1,000+

service technicians

25,000+

TK Elevator Corporation
788 Circle 75 Parkway SE
Suite 500
Atlanta, GA 30339
P: +1 844 427 5461
www.tkelevator.com/us



All illustrations and specifications are based on information in effect at time of publication approval.
TK Elevator reserves the right to change specifications or design and to discontinue items without prior notice or obligation.
© 2023 TK Elevator Corporation. CA License #C11-651371 | 29903-2 | endura brochure