



WYLTOR

SOLUTIONS

WE ELEVATE MOMENTS



WEELEVATEMOMENTS

At WYLTOR, for 45 years, we have been creating more than elevators. We create solutions that make our lives even better, that change our daily routines for the better.

What sets us apart and differentiates us in the elevator industry, is the commitment to the needs of each customer, with custom design solutions for special needs. In every partnership we follow three simple steps - research, design, implementation. With research, we lay the foundations of the partnership. By design, we create new possibilities. With the implementation we achieve our common goals.

OUR VALUES



RESPECT FOR
OUR CUSTOMERS



CUSTOMIZED
SOLUTIONS



EASY TO
INSTALL



24/7 AFTER
SALES SUPPORT



MODERN
DESIGN

45 YEARS AND COUNTING

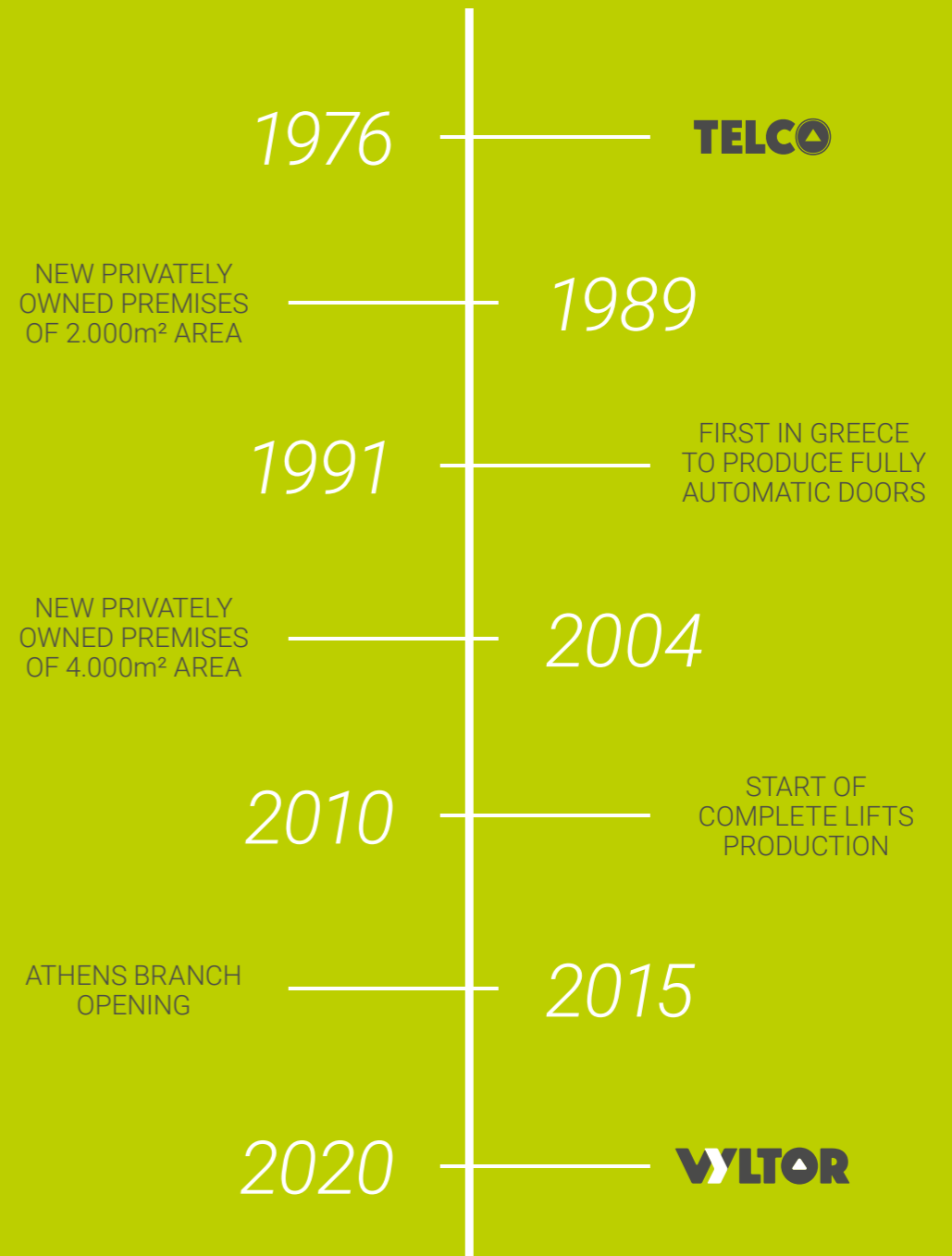

SOLUTIONS

Using cutting-edge technology and highly skilled engineers

we are innovators of solutions.

Our mission is to provide our customers with the highest quality and performance, lift solutions and services, tailored to their needs.

08-25

10 - 11
12 - 13
14 - 15
16 - 17
18 - 19
20 - 21
22 - 23
24 - 25

SPECS & MODELS

TMRL21L
TMRL21C
HYDRAULIC
TRACTION 1:1
TRACTION HOMELIFT
HYDRAULIC HOMELIFT
DUMBWAITER
CAR & CARGO

26-31

CABINS

32-35

DOORS

36-41

CONTROLLERS &
SIGNALIZATION

42-45

MODERNIZATION

46-49

ESCALATORS &
MOVING WALKS

50-53

ACCESSIBILITY

54-63

REFERENCES

SPECS & MODELS

Complete product flexibility
is what makes WYLTOR
your ideal partner in the
elevator industry.
Traction or hydraulic,
homelift, cargo & car lifts,
dumbwaiters,
you name it, we
deliver!





TMRL21L

Limited space? Spacious solution!

The TMRL.21L.2100 is a machine room less lift, one-side mechanical mounted support which is designed to fit and installed in buildings with restricted space for shafts. It is the ideal lift for existing buildings and for extremely limited spaces in the pit and in the headroom.

› up to triple access

Allows single 0°, double at 90° or 180° and triple access.

› maximum space efficiency of the shaft

The compact design of Wyltor's MRL lifts can be installed in almost any building and giving more space in the car.

› minimized time of installation

As a result of a plug' n play on all electrical parts and of pre-assembled mechanical parts of the lift.

› superior quality

100% produced in Europe by using exclusively leading brands in our products.

› comfort

Designed to give a smooth and a silenced operation enjoying every ride of the lift.

› energy efficiency

Is designed to minimize energy consumption from mechanicals parts and drives to car lighting.

› perfect leveling accuracy at every floor

After sales support 24/7 in immediate real time with high-qualified people.

› customized solutions

Special study and design according to needs or requirements of a building.

TECHNICAL DATA		
LOAD	300 - 630 kg	750 - 1000 kg
MAX SPEED	1 m/s	
MINIMUM PIT	1000 ¹ / 340 ²	1000 ¹ / 440 ²
MINIMUM HEADROOM	3400 ¹ / 2680 ²	3400 ¹ / 2800 ²
ROPING	2:1	
ENTRANCES	Single / Double 90° or 180° / Triple access	
CONTROL SYSTEM	LC 100	
MAXIMUM TRAVEL	40m	

Cabin CH=2300mm (External)
 1. According to EN81.20
 2. According to EN81.21

ENERGY EFFICIENCY CLASS A

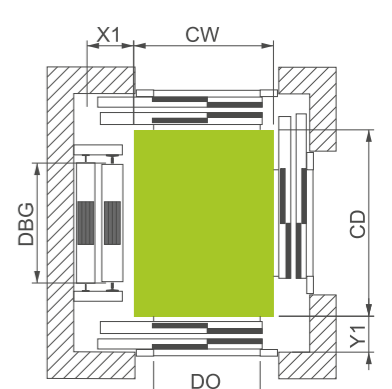
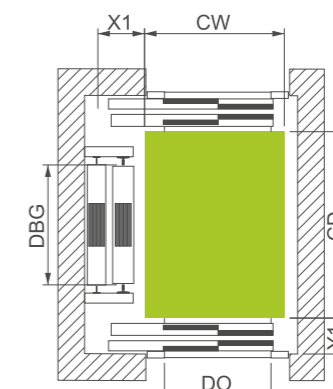
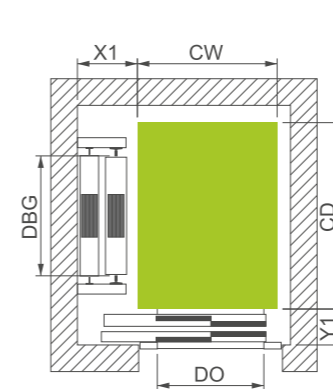
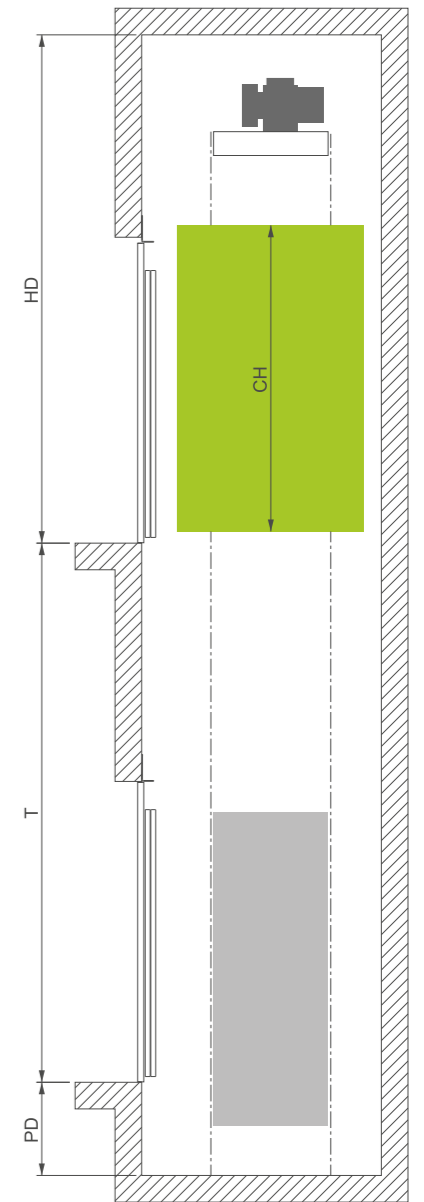

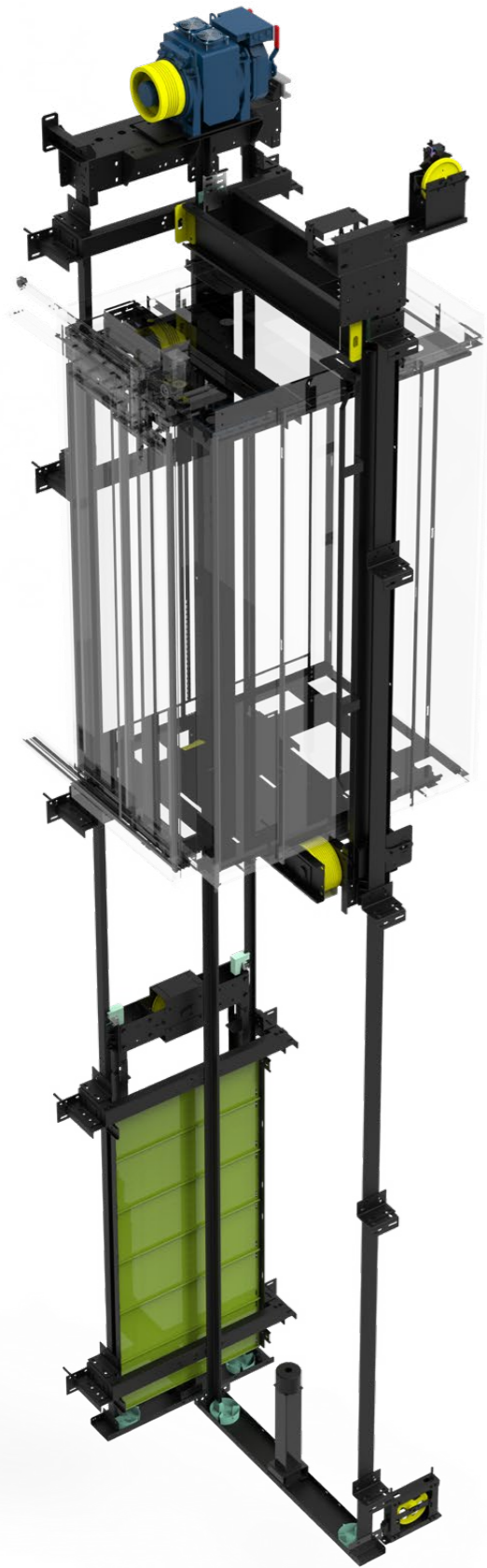

TMRL21C

The ideal solution for high rise buildings.

The TMRL.21C is a machine room less lift, designed to cover a wide range of buildings, such as residential buildings, offices buildings, hotels, hospitals and shopping centers. It requires less space and lower energy consumption.

› comfort

Designed to give a smooth and a silenced operation enjoying every ride of the lift.

› easy to install

As a result of a plug' n play on all electrical parts and of pre-assembled mechanical parts of the lift.

› energy efficiency

Is designed to minimize energy consumption from mechanicals parts and drives to car lighting.

› superior quality

100% produced in Europe by using exclusively leading brands in our products.

› destination control system

Efficient destination control solution for optimizing waiting + travel time and energy consumption. Reducing crowd in cars, number of stops per trip and getting lobbies more organized during rush hours.

› customized solutions

Special study and design according to needs or requirements of a building.

TECHNICAL DATA				
LOAD	300 - 1000 kg		1000 - 2000 kg	
MAX SPEED	1 m/s	1,6 m/s	1 m/s	1,6 m/s
MINIMUM PIT	1050 ¹ / 500 ²	1250 ¹ / 1000 ²	1150 ¹ / 600 ²	1350 ¹ / 1100 ²
MINIMUM HEADROOM	3350 ¹ / 3050 ²	3400 ¹ / 3100 ²	3750 ¹ / 3200 ²	3800 ¹ / 3250 ²
ROPING	2:1		2:1	
ENTRANCES	Single / Double 180°			
CONTROL SYSTEM	LC 100			

Cabin CH=2300mm (External)
1. According to EN81.20
2. According to EN81.21

ENERGY EFFICIENCY CLASS A

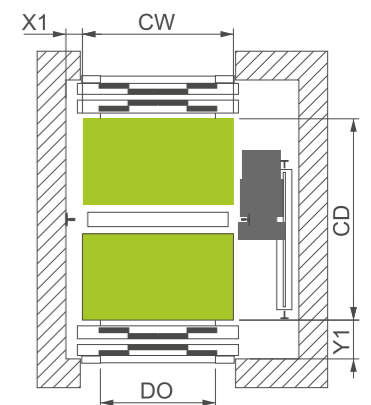
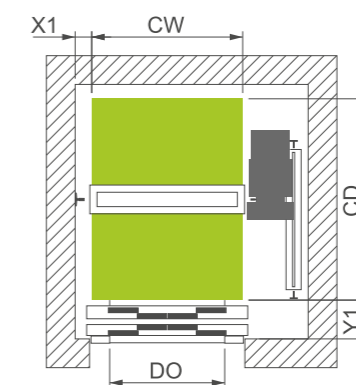
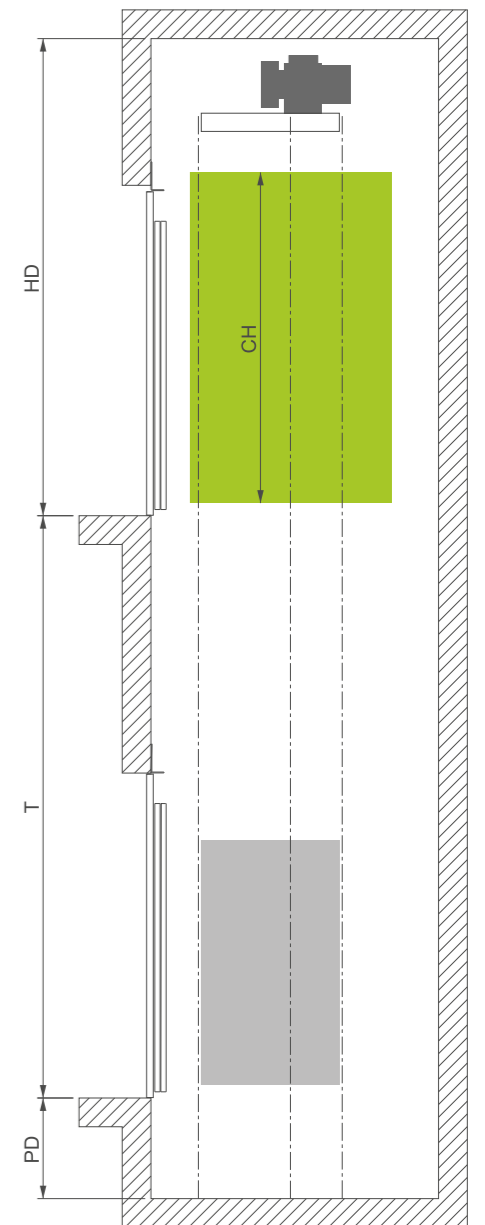

HYDRAULIC

Low traffic? High demands!

The hydraulic lift is suitable for residential buildings with low traffic and up to 4 to 5 stops with limited space for shaft. It can be installed in buildings with or without machine room and offers an excellent ride with an excellent stopping accuracy at every floor.

› quick & easy to install

Designed and delivered in pre-assembled mechanical parts and in plug'n'play electrical parts. Suitable for 2 to 6 stops.

› superior quality

100% produced in Europe by using exclusively leading brands in our products

› provided with a standard UPS system in case of a power supply failure

› maximum space efficiency of the shaft

Ideal for shaft with reduced pit and headroom. Controller and power unit available in a cabinet.

› comfort

Smooth ride with a soft stop and a soft start function and an exceptional stopping accuracy in every level.

› customized solutions

Special study and design according to needs or requirements of a building.

TECHNICAL DATA		
LOAD	300 - 630 kg	750 - 1500 kg
MINIMUM PIT	980 ¹ / 450 ²	1050 ¹ / 520 ²
MINIMUM HEADROOM	3350 ¹ / 2880 ²	3350 ¹ / 2930 ²
ROPING	2:1	
MAX SPEED	0.63	
ENTRANCES	Single / Double 90° or 180° / Triple access	
CONTROL SYSTEM	LC 100	

Cabin CH=2300mm (External)
1. According to EN81.20
2. According to EN81.21

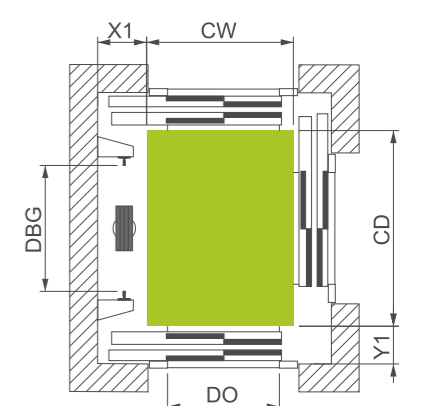
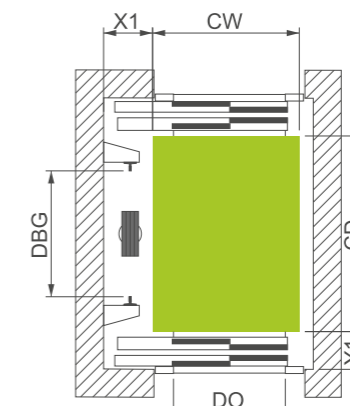
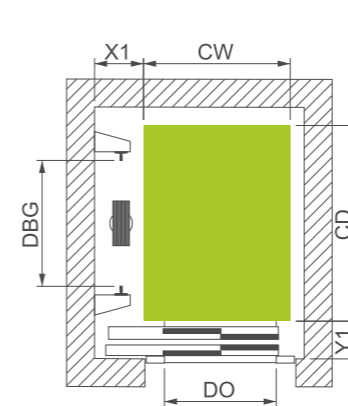
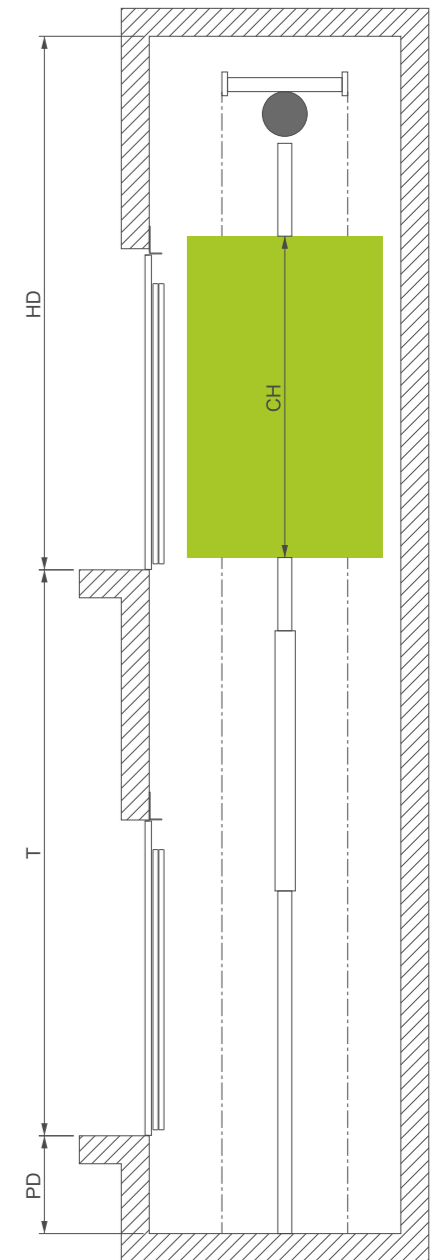

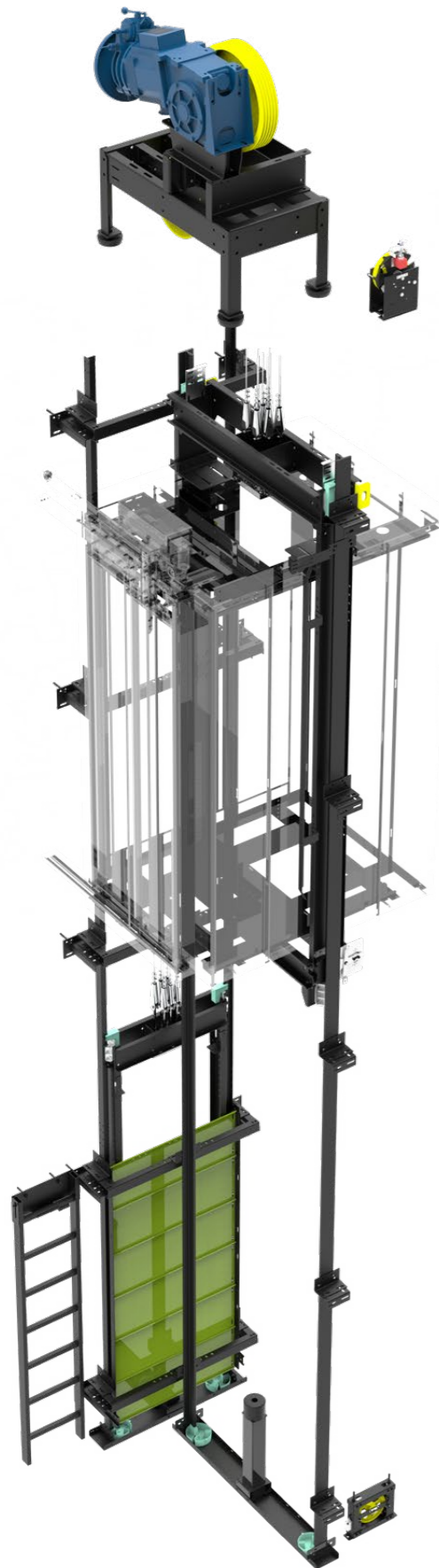

TRACTION 1:1

High Quality. High Rise. High Expectations.

Traction lifts with a machine room are suitable for high-rise buildings. They are also often can be installed and replace old lifts in buildings with an existing machine room.

- › suitable for high rise buildings
- › unique solution to replace lifts in a building that already have a machine room
- › superior quality
Efficient destination control solution for optimizing waiting + travel time and energy consumption, reducing crowd in cars, reducing number of stops per trip and getting lobbies more organized during rush hours.
- › customized solutions
special study and design according to needs or requirements of a building.

TECHNICAL DATA	
LOAD	300 - 1000 kg
MAX SPEED	1 m/s 1,6 m/s
MINIMUM PIT	940 ¹ / 400 ² 1200 ¹ / 1000 ²
MINIMUM HEADROOM	3350 ¹ / 3050 ² 3400 ¹ / 3100 ²
ROPING	1:1
ENTRANCES	Single / Double 180°
CONTROL SYSTEM	LC 100

Cabin CH=2300mm (External)
1. According to EN81.20
2. According to EN81.21

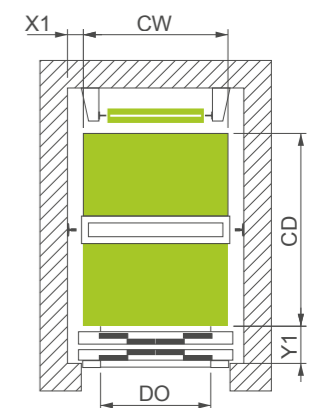
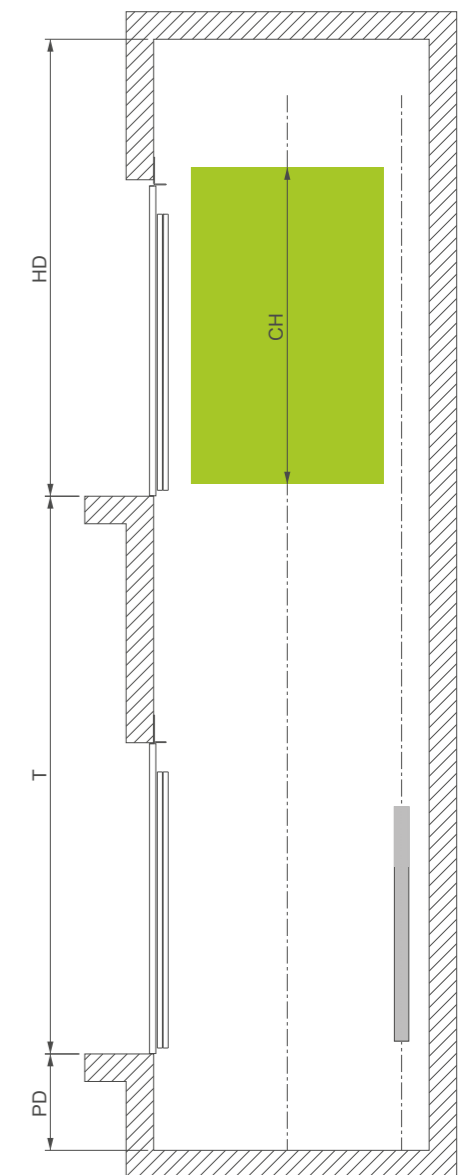

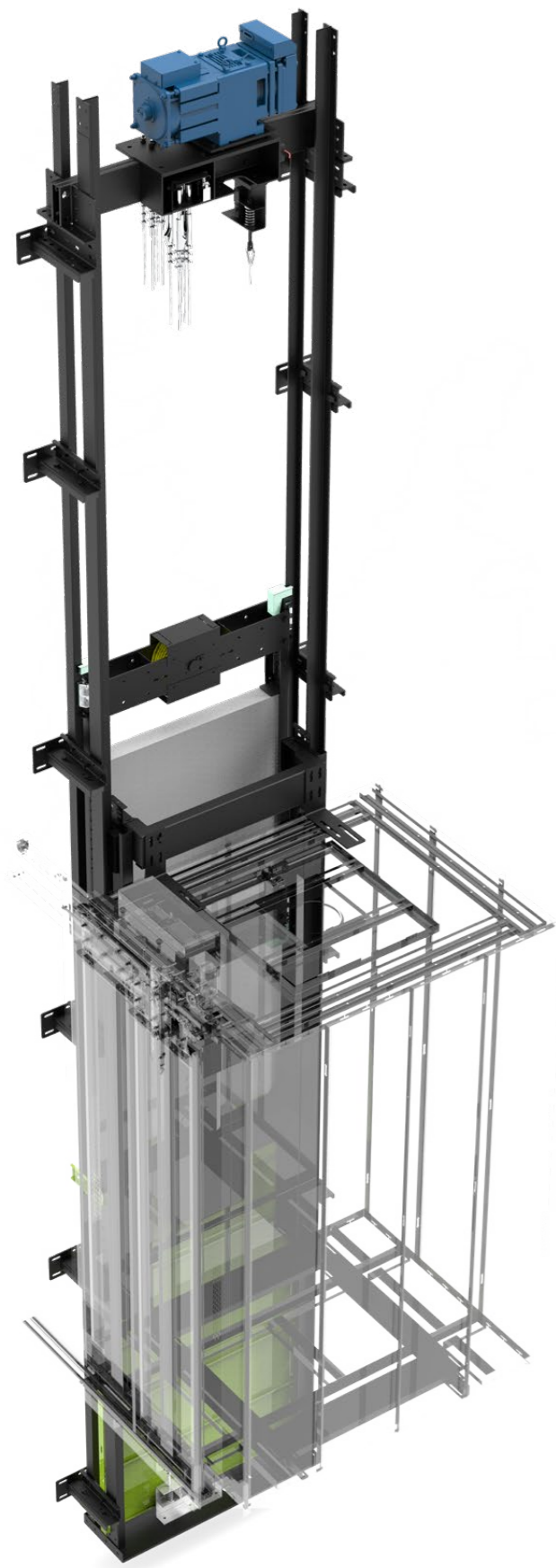

TRACTION HOMELIFT

The ideal solution for your home.

Traction home lift is the perfect solution for private houses. Requires minimum space and operates at extremely low noise levels with no vibration and with a very low energy consumption. Is available with automatic or semiautomatic doors and in a monophasic or a three phase power supply.

- › **minimized energy consumption**
With a single or a three phase power supply.
- › **comfort**
Designed to give a smooth and a silenced operation.
- › **superior quality**
100% produced in Europe by using exclusively leading brands in our products.
- › **reduced spaces**
Requires minimum pit and headroom.
- › **quick and easy to install**
- › **provided with a standard UPS system in case of a power supply failure**
- › **certified according to Machinery Directive 2006/42/EC**
- › **bespoke and flexible designed solutions according to every need**
- › **perfect leveling accuracy at every floor**

TECHNICAL DATA	
LOAD	225 - 400 kg
MAX SPEED	0,15 m/s (EU standards) / 0,30 m/s (Non EU standards)
MINIMUM PIT	150mm
MINIMUM HEADROOM	2600 ¹ / 2400 ²
ROPING	2:1
ENTRANCES	Single / Double 90° or 180° / Triple access
CONTROL SYSTEM	LC 100

Cabin CH=2200mm (External)
 1. According to 2006/42/EC
 2. According to EN81.41, without car door

ENERGY EFFICIENCY CLASS A

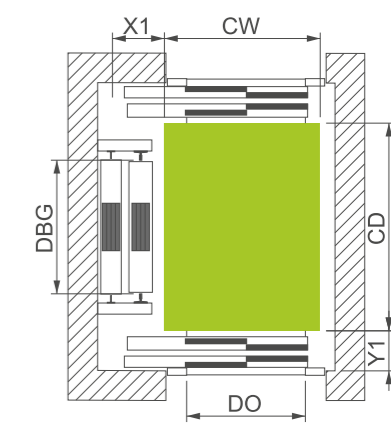
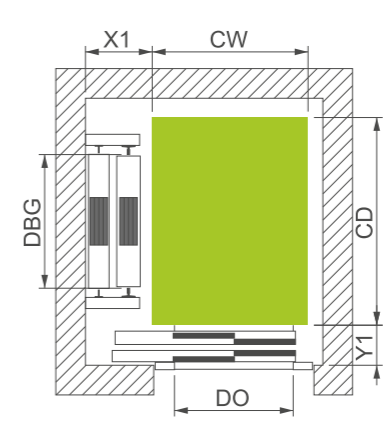
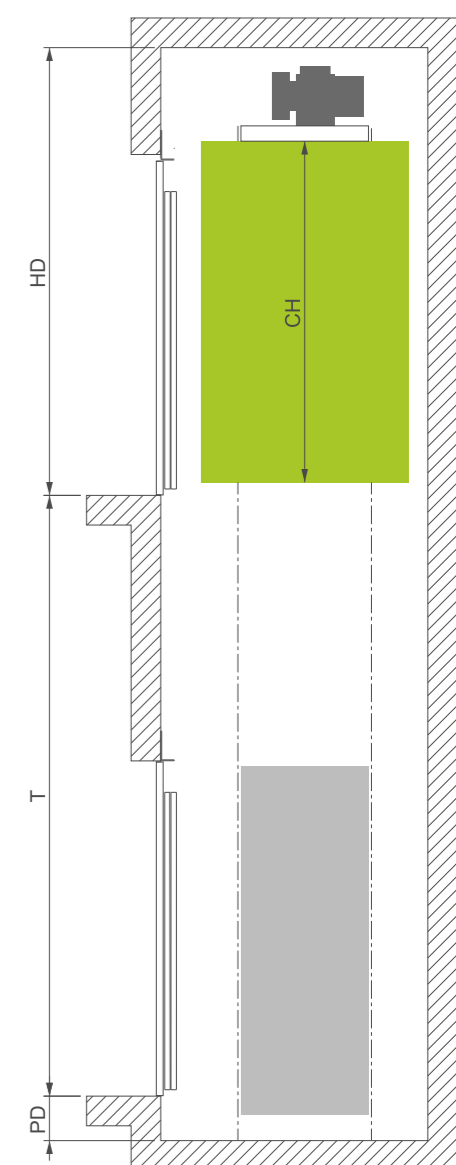

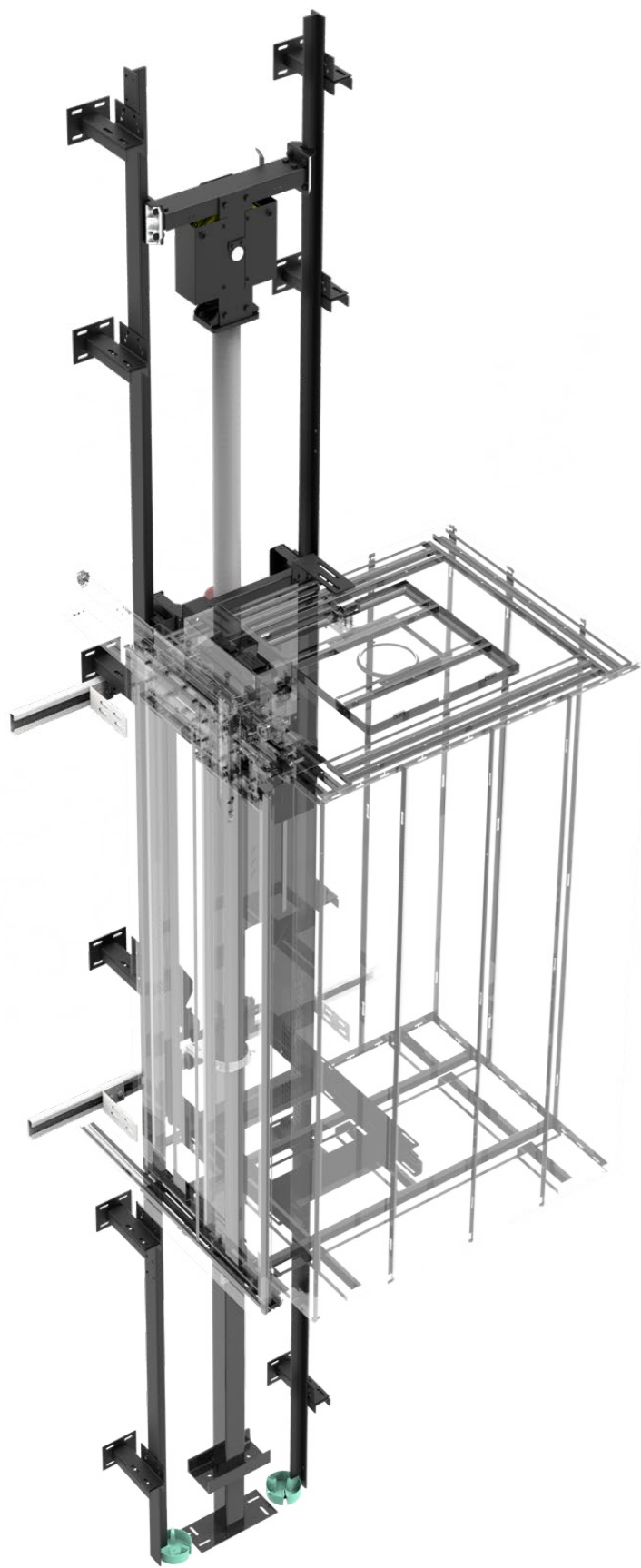

HYDRAULIC HOMELIFT

Sweet dreams. Smooth & silent ride!

Hydraulic home lift is the ideal lift for private houses and a value for money solution. It can be installed in shafts with pit and headroom limitations with either automatic or semiautomatic doors.

- › **minimized energy consumption**
With a single or a three phase power supply.
- › **comfort**
Designed to give a smooth and a silenced.
- › **superior quality**
100% produced in Europe by using exclusively leading brands in our products.
- › **reduced spaces**
Requires minimum pit and headroom.
- › **quick and easy to install**
- › **provided with a standard UPS system in case of a power supply failure**
- › **certified according to Machinery Directive 2006/42/EC**
- › **bespoke and flexible designed solutions according to every need**
- › **perfect leveling accuracy at every floor**

TECHNICAL DATA	
LOAD	225 - 400 kg
MAX SPEED	0,15 m/s (EU standards) 0,30 m/s (Non EU standards)
MINIMUM PIT	150mm
MINIMUM HEADROOM	2600 ¹ / 2300 ²
ROPING	2:1
ENTRANCES	Single / Double 90° or 180° / Triple access
CONTROL SYSTEM	LC 100

Cabin CH=2200mm (External)
 1. According to 2006/42/EC
 2. According to EN81.41, without car door

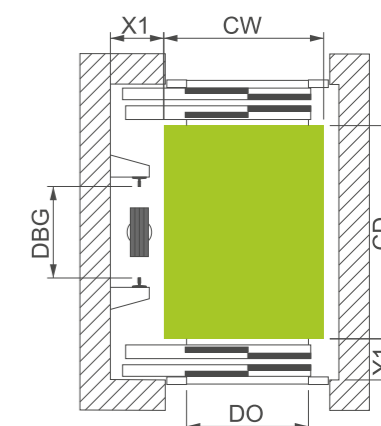
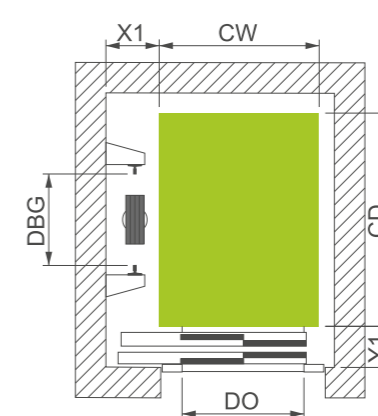
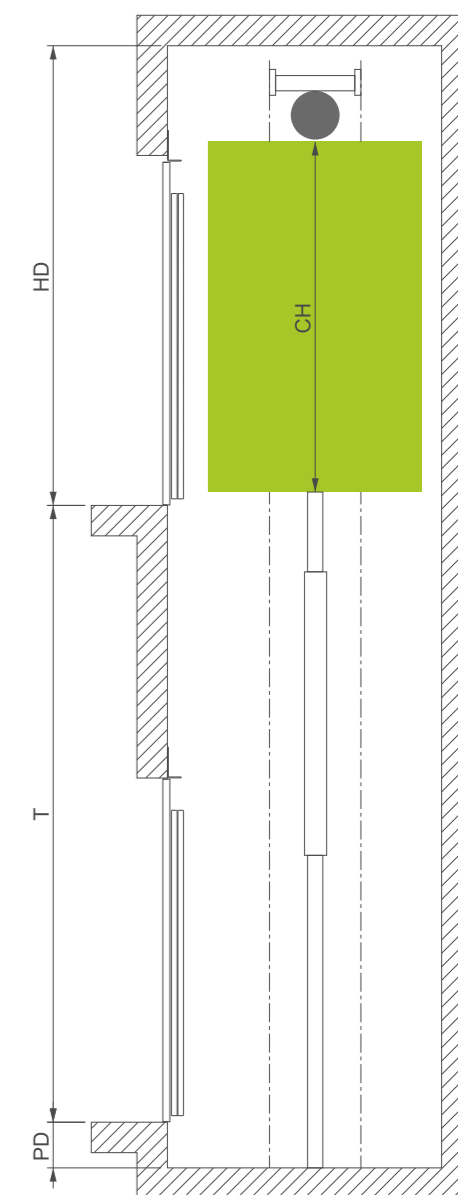



DUMB-WAITER

The perfect solution for lifting goods!

Dumbwaiter is a small freights traction lift for lifting goods such as food, clothes and others. It is the perfect solution for restaurants, hotels and even for private houses.

- › ideal solution for hotels, restaurants and shopping centers
- › roping 1:1
- › smooth operation with a VVVF solution in controller
- › speed 0,4m/s and up to 100kg load
- › minimum space and no machine room are required
- › premium stainless steel to meet hygiene requirements

TECHNICAL DATA	
LOAD	50 - 100 kg
MAX SPEED	0,4m/s
MAX TRAVEL	18m
SERVICE HEIGHT	600mm
ROPING	1:1
CONTROL SYSTEM	LC 100 / VVVF optional

According to Directive 2006/42/EC



CAR- CARGO

Created for your
biggest challenges.

The powerful, robust and high-performance WYLTOR car & cargo lift is ideal for a multitude of extremely demanding vertical freight transportation tasks in any type of building: supermarkets, shopping centres, airports, warehouses, hospitals, hotels, industrial plants and offices.

Those heavy lifters are designed specifically for durable and smooth rides in order to best handle fragile loads, and accurate leveling for easy loading and unloading.

Speed and power, alongside premium-quality design, aren't compromised. WYLTOR's reliable operation and excellent ride quality helps to protect fragile loads, making sure both passengers and loads have a smooth ride.

The cabins are built for the heaviest of uses, with finishes in stainless steel or powdercoated paint and protected by buffer rails.

We offer a wide selection of wall, floor and landing-door materials, giving you the chance to seamlessly integrate the cabin with the building's interior design.





CABIN S

A cabin, with a unique character and creative design, can contribute to the design identity of the entire building. A well-designed elevator can make the difference in the way people interact with the building, whether it's a hotel, residential or office buildings, or even department stores,

each transportation evolves into an impressive experience!

Modern and elegant lines, intense or discreet lighting, earthy or pop shades. Make it yours!



SMARTDESIGN
ERAGON
ANTHRACITE

- CEILING**
Type: 013, Epoxy Paint Anthracite Brushed
- WALLS**
Epoxy Paint Anthracite Brushed
- FLOOR**
Coin Grip Plastic Floor
- HANDRAIL**
Curved Handrail, Stainless Steel Mirror
- COP**
Standard full height, Mirror
- SKIRTINGS**
Stainless Steel Mirror
- MIRROR**
Full height - Half width



SMARTDESIGN
ERAGON
1013

- CEILING**
Type: 013, Epoxy Paint RAL 1013
- WALLS**
Epoxy Paint RAL 1013
- FLOOR**
Plastic Floor T30
- HANDRAIL**
Standard Handrail, Stainless Steel Satine
- COP**
Wyltor short, Stainless Steel Satine
- SKIRTINGS**
Epoxy Paint RAL 1013
- MIRROR**
Half height - Half width

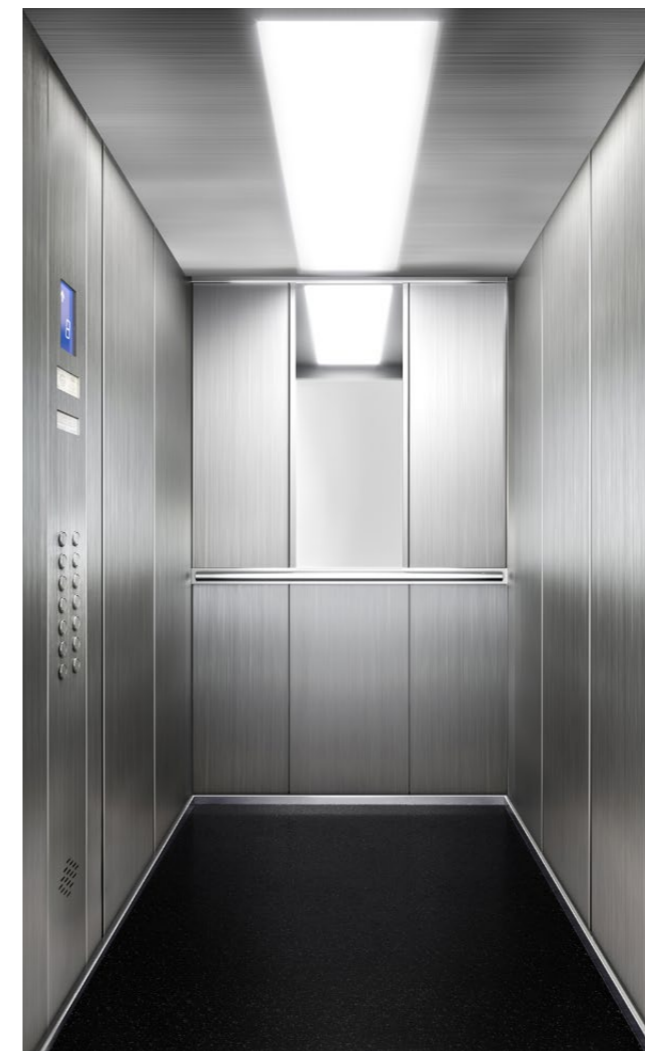

SMARTDESIGN
ERAGON
INOX

- CEILING**
Type: 014, Stainless Steel Satine
- WALLS**
Stainless Steel Satine
- FLOOR**
Plastic Floor T35
- HANDRAIL**
Standard Handrail, Stainless Steel Mirror
- COP**
Standard full height, Stainless Steel Satine
- SKIRTINGS**
Stainless Steel Satine
- MIRROR**
Half height - 1/3 width

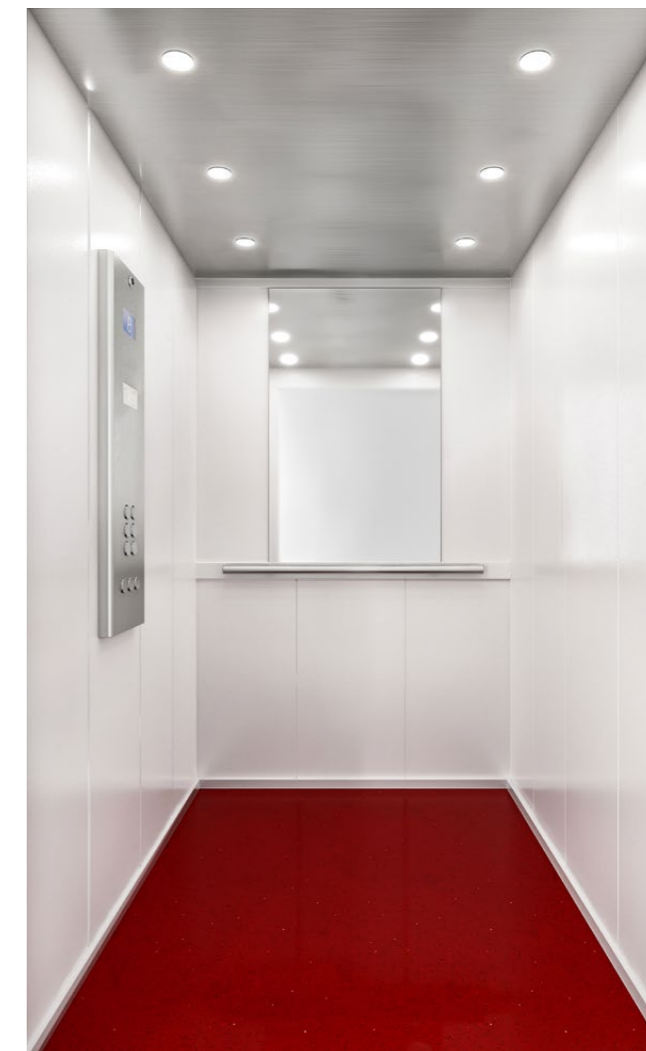

SMARTDESIGN
ERAGON
WHITE

- CEILING**
Type: 015, Stainless Steel Satine
- WALLS**
Epoxy Paint RAL 9003
- FLOOR**
Starlight Red
- HANDRAIL**
Standard Handrail, Stainless Steel Satine
- COP**
Wyltor short, Stainless Steel Satine
- SKIRTINGS**
Epoxy Paint RAL 9003
- MIRROR**
Half height - Half width



SMARTDESIGN
ERGON
7032

- CEILING**
Type: 013, Epoxy Paint RAL 7032
- WALLS**
Epoxy Paint RAL 7032
- FLOOR**
Plastic Floor T11
- HANDRAIL**
Standard Handrail, Stainless Steel Satine
- COP**
Wyltor short, Epoxy Paint RAL 7032
- SKIRTINGS**
Epoxy Paint RAL 7032
- MIRROR**
Half height - Half width

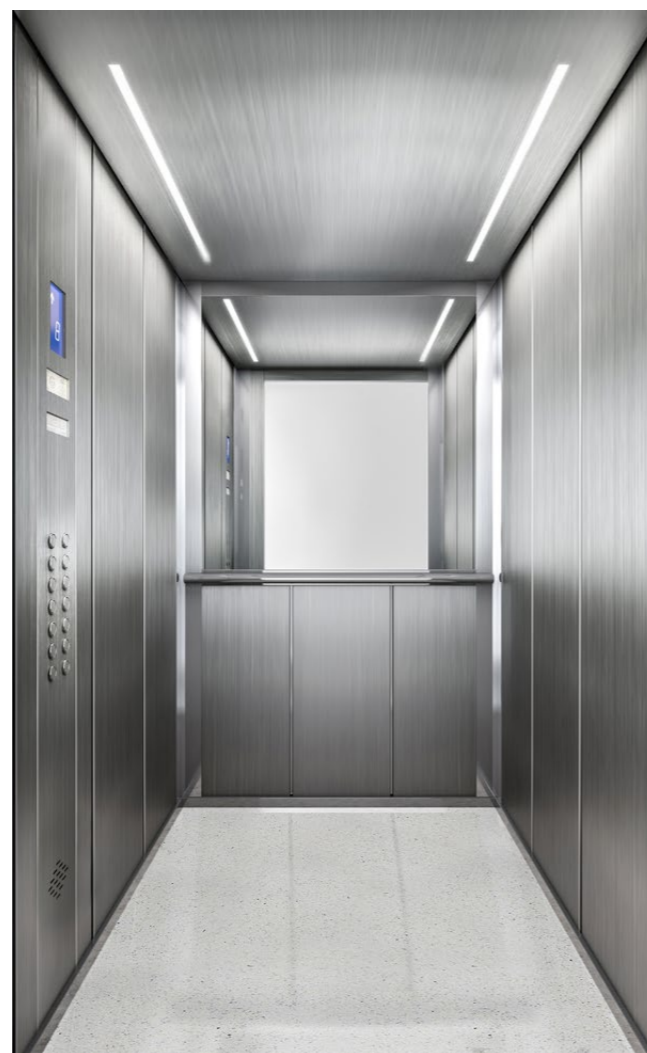

COMFORTDESIGN
INOX
EXELIXIS

- CEILING**
Type: 016, Stainless Steel Satine
- WALLS**
Stainless Steel Satine
- FLOOR**
Starlight White
- HANDRAIL**
Standard Handrail, Stainless Steel Mirror
- COP**
Standard full height, Stainless Steel Satine
- SKIRTINGS**
Stainless Steel Mirror
- MIRROR**
Half height - Full width



COMFORTDESIGN
KINISIS
602

- CEILING**
Type: 015, Stainless Steel Satine
- WALLS**
Laminate 602
- FLOOR**
Plastic Floor T35
- HANDRAIL**
Standard Handrail, Stainless Steel Satine
- COP**
Standard full height, Stainless Steel Satine
- SKIRTINGS**
Stainless Steel Satine
- MIRROR**
Half height - Full width

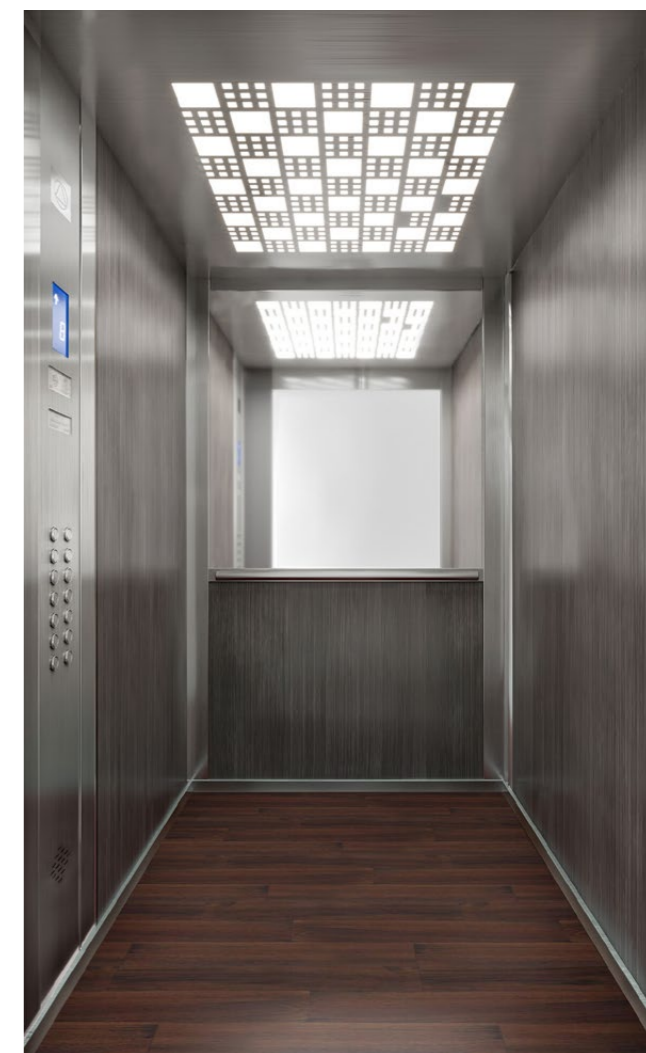

COMFORTDESIGN
KINISIS
606

- CEILING**
Type: 06, Stainless Steel Satine
- WALLS**
Laminate 606
- FLOOR**
Wooden Floor
- HANDRAIL**
Standard Handrail, Stainless Steel Satine
- COP**
Standard full height, Stainless Steel Satine
- SKIRTINGS**
Stainless Steel Satine
- MIRROR**
Half height - Full width

DOORS

Our doors are well designed, compact and durable, so that they can ensure the smoothest and safest functionality for both people and goods.

no matter what your building is used for, people can move around safely and comfortably.



WYLTOR has been designing and manufacturing its own range of automatic doors for the last 30 years.

WYLTOR doors are carefully designed with detailed precision ensuring ultimate functionality and maximum resistance to extreme operating conditions. WYLTOR's experience in manufacturing automatic doors allows it to use this key advantage in order to provide reliable and customized solutions for any building need.



Advantages of WYLTOR landing doors

- › Wide range of clear opening widths (600mm÷4000mm) and height (2000mm÷3000mm)
- › Central opening from 2-panel to 8-panel
- › Telescopic opening from 1-panel to 4-panel
- › Easy installation and maintenance
- › Minimum installation and maintenance cost
- › Great flexibility in special constructions
- › Variety of colours and coatings of stainless steel

Advantages of WYLTOR VVVF car doors

- › Easy and guided set-up of the doors' operating parameters with the help of special parameters such as speed and opening and closing force, acceleration-deceleration of movement, return of opening
- › Minimum number of mechanism components, resulting in excellent function and absence of failures, during lift operation
- › Integrated automatic release in case of power failure
- › Automatic correction of any damage of the electronic board
- › 400 kg maximum tractive weight using a single engine
- › Factory adjustment of the door's operating parameters depending on the lift type
- › Works with all types of lift electrical panels, photocells and photocurtains
- › Minimum number of connecting wires to the board
- › Installation, cooperation and flawless operation with a wide range of different types of landing doors in cases of renovation and replacement
- › Quick delivery time (in special cases within 1 week)



Semiautomatic doors

WYLTOR's semi-automatic doors are robust, reliable and durable. They are produced and available in standard and no standard dimensions and are the perfect solution for limited shaft dimensions and structures with high strength requirements.

CONTROL LERS &

SIGNAL IZATION



WYLTOR's control technology is sophisticated, based on the latest technology, and can improve the performance, reliability, safety & energy efficiency of your elevator!

CONTROL LERS

WYLTOR LC100 CONTROL SYSTEM



LC100 is a micro-controller using CAN BUS communication system. It has the ability to control up to 8 lifts for up to 40 stops and up to a speed of 4m/s. It offers complete logging of functions and faults providing the corresponding statistic results that help to reduce and to eliminate lift malfunctions.

The entire electrical installation is thoroughly checked, as well as all electrical components required for each lift order. The setting procedure includes tuning the control with the motor for each order, "tune and phase of motor".

› fully plug' n play prewired system

LC100 is supplied pre-assembled, pre-connected and pre-tested. Entire electrical installation is thoroughly checked which minimizes time of installation.

› 100% pre-tested

Pre testing procedure includes tuning the controller with the motor of each order. Standard procedure of "tune and phase of motor".

› fully programmable and adjustable at site

› one terminal point for any use

LC100 allows a single person to adjust parameters and function of the lift connected to either in and over the cabin, in pit station and in every single LOP.

› up to 8 lifts controlled and up to a speed of 4m/s

› destination control system

Efficient destination control solution for optimizing waiting + travel time and energy consumption, reducing crowd in cars, reducing number of stops per trip and getting lobbies more organized during rush hours.

› flexible designed solutions for every need of electrical parts of the lifts

LC100 offers numerous programmable functions of the lifts and multilanguage support on controller terminals

› superior quality components by using exclusively leading brands as our suppliers

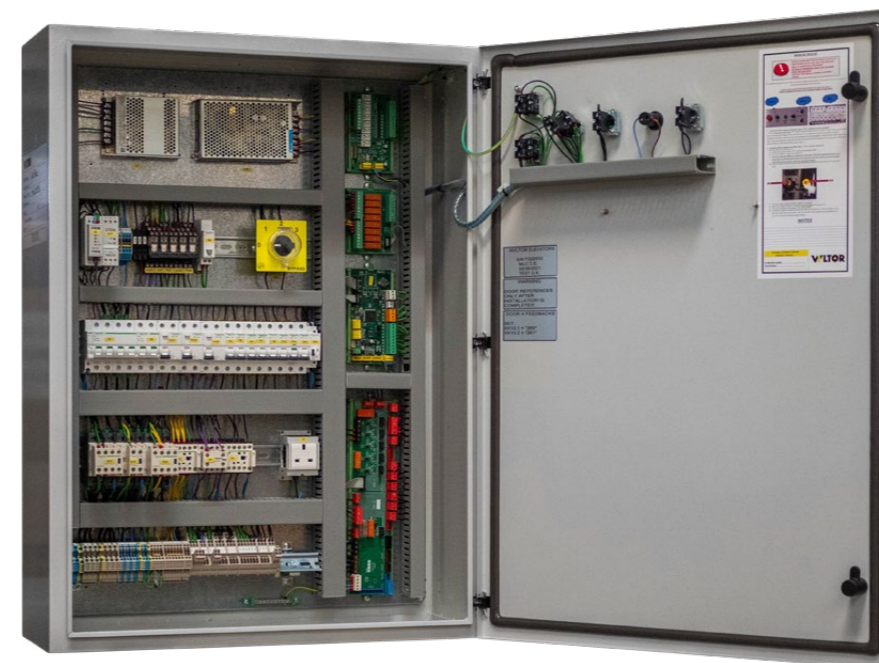

SIGNALIZATION

Signalization for many is considered just an add-on, but for us is an essential part of the functionality and the overall cabin design.

Personalize the Car Operating Panels as well as the Landing Panels, according to your needs and aesthetics, in order to better match the looks and feeling of your building.



Hall lantern



COP & LOP

You can make your Car and Landing operating panels not only functional, but stylish as well. Inox satine or mirror and even epoxy painted with a RAL colour of your choice can really level up the user's experience. For those looking for a more modern-looking feel, we can also offer coloured glass panels with touch buttons

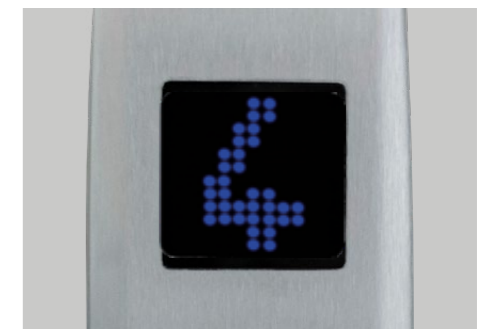

M6B

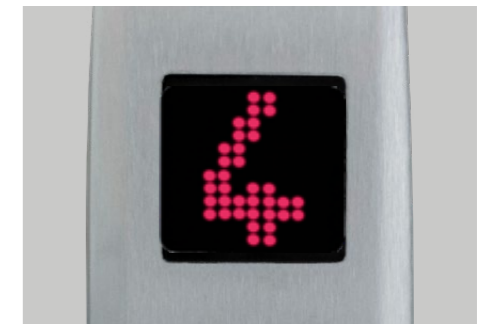

M6R



M6W



Indicators

Three colour choices for the indicators that can really give your panels a personalized feel. Choose between blue, red and white colours and make your lift stand out!

A close-up photograph of an elevator control panel and handrail. The control panel is black with several circular buttons, some of which are numbered 1 through 7. The handrail is a polished, cylindrical metal bar. The background is dark and out of focus.

MODERNIZATION

Time runs for everyone, that goes for your elevator too! To increase the value of your building and keep your elevator reliable and safe for the passengers, it's recommended to upgrade some of its key features to

- Performance
- Safety
- Aesthetics
- Accessibility
- Regulations

WYLTOR can provide you with component upgrades if you wish to make small improvements to your lift. Upgrades can cover door operator, signalization, cabin aesthetics and more.



▲ Doors

You can increase your car doors and landing doors safety at any time with minimum installation and maintenance cost. Choose between telescopic or central opening landing doors and a variety of colours and coatings of stainless steel to match your building. A plus is that our car doors can work with all types of lift electrical panels, photocells and photocurtains. Semiautomatic doors are also available and are the perfect solution for limited shaft dimensions.

Signalization

Upgrading the signalization of your lift gives a stylish new feeling to your cabin and upgrades the user experience. A lot of options are available for you to choose from. Dot matrix or segment display with red or blue coloured indicators, as well as touch COP/LOP buttons or classic ones with braille code.



Cabin ▶

If you feel your cabin is outdated you can always modernize it by bringing it to the modern age. You can freshen it up with a unique design and feeling choosing from the variety of materials we offer for the side panels, floors and false ceilings, or you can simply choose one of our proposed cabins our designers curated for you!

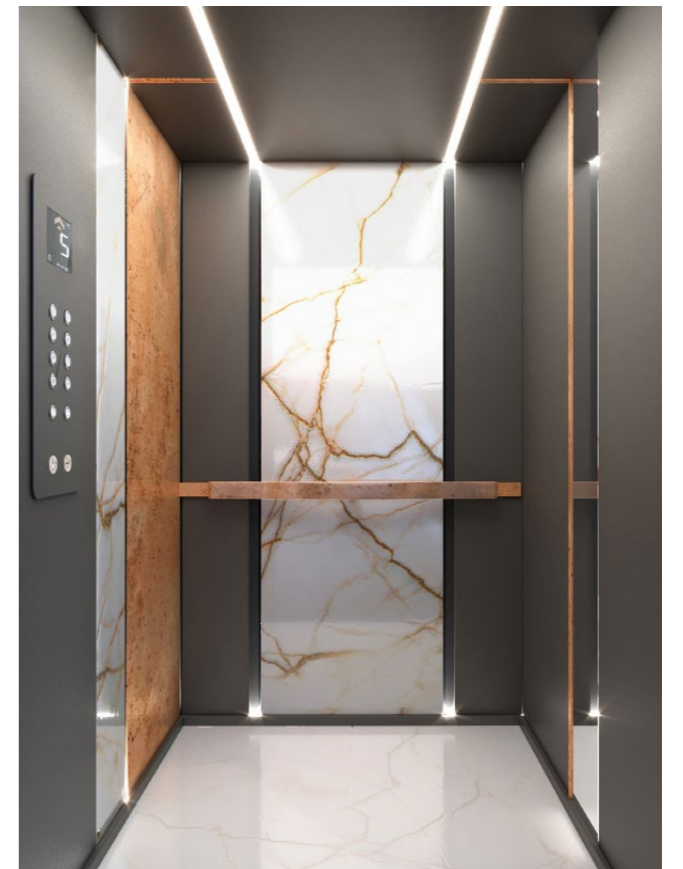

Controller

Make your life easier with our controllers! We offer fully plug' n play prewired system, fully programmable and adjustable at site for your ease and flexible designed solutions for every need of electrical parts of the lifts.



ESCA LAT OR S &

No matter your needs and your building requirements, in terms of escalators and moving walks, WYLTOR can meet the challenge.

Whether its an indoor or outdoor installation, our specialized staff will guide you to the best possible solution for

Public transportation
Airports
Subway
Hotels
Hospitals

MOVING WALKS



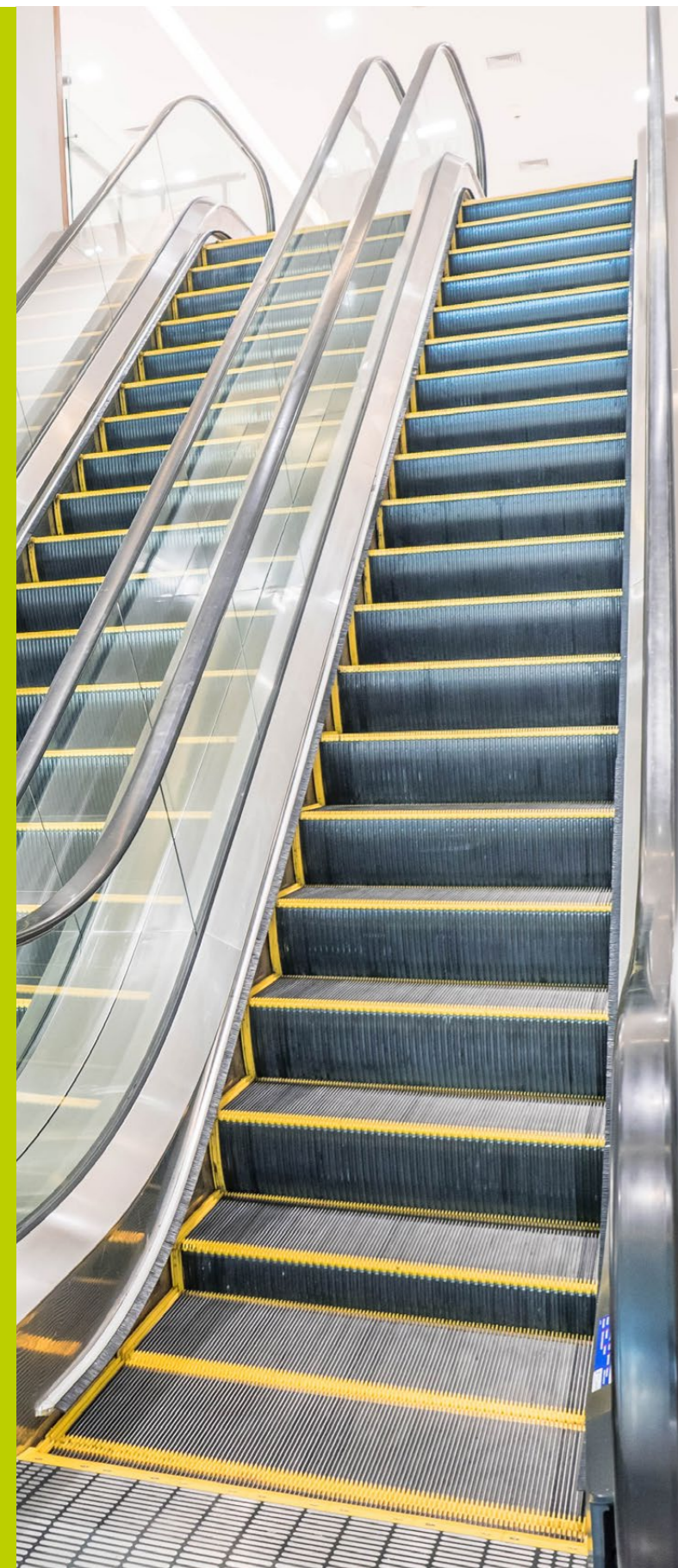

ESCALATORS

Uncompromised quality & safety!

WYLTOR in collaboration with leading factories, offers escalator solutions for a variety of buildings, including supermarkets, shopping centres and airports. Safe and comfortable transportation, smooth operation (VVVF), low noise level and energy saving are some of the features offered.

Adding the flexible design, indoor-outdoor installation and easy maintenance and you can tell WYLTOR is your trusted partner.

ESCALATORS	
INCLINE ANGLE	30° / 35°
STEP WIDTH	600mm/800mm/1000mm
HORIZONTAL STEPS	2/3
SPEED	0,5 m/s
INCLINE	≤6m
USAGE	REGULAR/OFTEN
INSTALLATION	INTERIOR/EXTERIOR

MOVING WALKS

Move along with safety.

WYLTOR in collaboration with leading factories, offers moving walk solutions for a variety of buildings, including supermarkets, shopping centres and airports. Safe and comfortable transportation, smooth operation (VVVF), low noise level and energy saving are some of the features offered.

Adding the flexible design, indoor-outdoor installation and easy maintenance and you can tell WYLTOR is your trusted partner.

MOVING WALKS	
INCLINE ANGLE	10° / 11° / 12°
STEP WIDTH	800mm/1000mm
SPEED	0,5 m/s
INCLINE	≤6m
USAGE	REGULAR/OFTEN
INSTALLATION	INTERIOR/EXTERIOR





ACCESS IBILITY

As the world moves forward, demands for accessible solutions increase.

Elderly people and people with impaired mobility need to move without any difficulty, whether its in a public building, in transportation hubs or even their own private home.

lets make the most we can for those that need it the most!

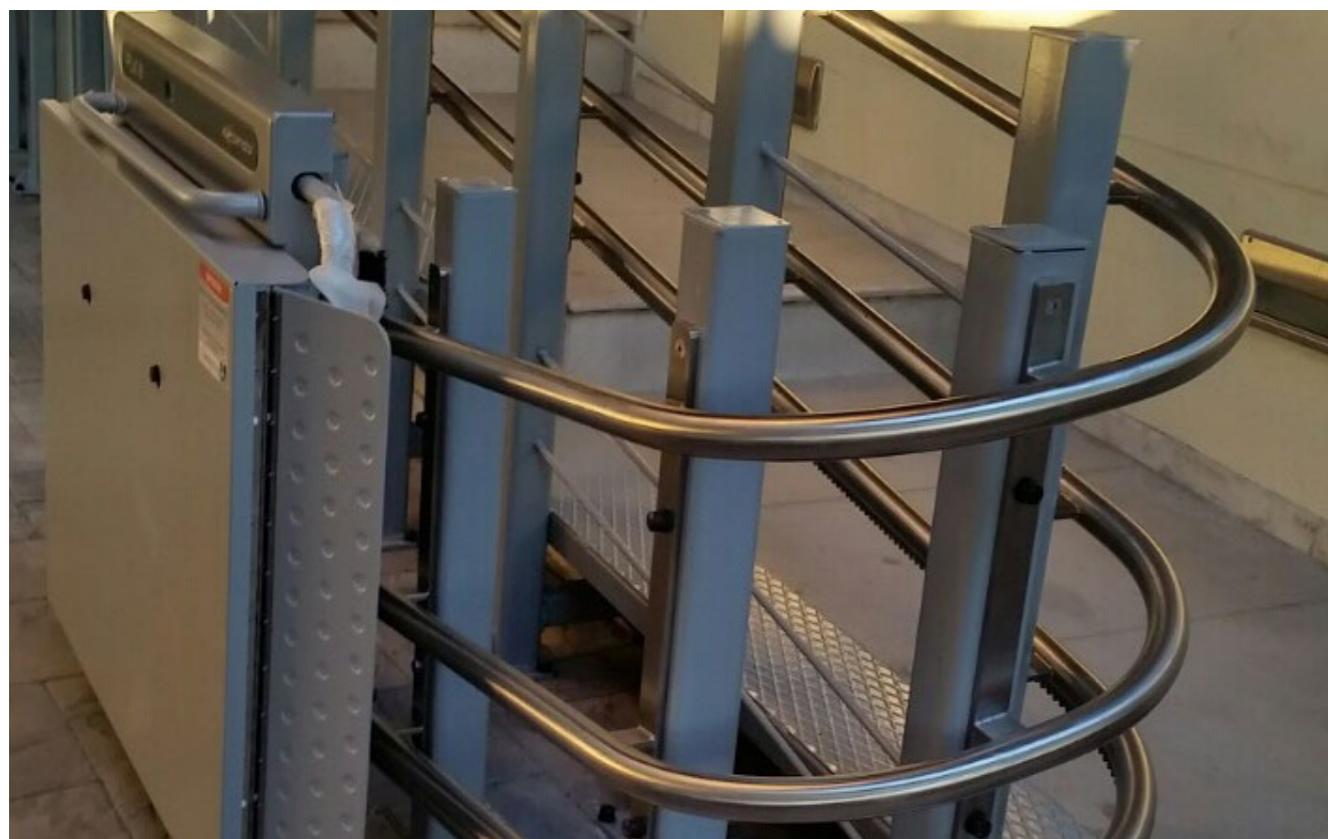

Solutions accessible for all.

Wyltor offers stair lift systems that are ideally installed in all types of stairways both indoors and outdoors. They require minimal space, can be installed on a straight or curved staircase, they provide maximum safety during use and need minimal maintenance.

a) platform stairlift for wheelchair

Wheelchair platform stairlift is the ideal solution for accessing buildings where using a lift is not possible. It can be installed on the wall or the floor, outdoors and indoors, at an angle or with vertical lifting.

b) stairlift

Stairlifts are designed to provide a solution for people with difficulty in climbing stairs. Designed for all staircase sizes and shapes on special order for ideal installation and use. It is installed on any indoor or outdoor, straight or curved staircase. Stairlifts are available in a variety of colours and materials and come with an EC declaration of conformity.

PLATFORM STAIRLIFT	
LOAD	UP TO: 300 kg
USAGE	INTERIOR/EXTERIOR
SPACE NEEDED	STRAIGHT: 25cm INCLINED: 31cm
PLATFORM DIMENSIONS	800x800 / 800x750 / 800x700 / 800x650 900x800 / 900x750 1000x800 / 1000x700 1000x900 / 1210x830 / 1250x800 / 1300x800
MACHINE	24V DC
COLOURS	Standard 9006*
NOISE LEVELS	Lower than 63 dB
SPEED	0,15m/s
CERTIFICATION	EC type examination certificate

VERTICAL PLATFORM STAIRLIFT PLV9	
LOAD	225kg
USAGE	INTERIOR/EXTERIOR
SPACE NEEDED	STRAIGHT: 25cm INCLINED: 31cm
PLATFORM DIMENSIONS	800x800 / 800x750 / 800x700 / 800x650 900x800 / 900x750 1000x800 / 1000x700 1000x900 / 1210x830 / 1250x800 / 1300x800
MACHINE	24V DC
COLOURS	Standard 9006*
NOISE LEVELS	Lower than 63 dB
SPEED	0,15m/s

*Available with all RAL colours and st/st





WYLTOR has a strong presence in the international market and exports its products to 33 countries!

Flexibility in lift study and design offers solutions that comply with national law requirements and any construction needs required.

REF ER ENC S



TOWER
LIMASSOL, CYPRUS
2 Elevators
15 Stops



ALIMOS PEDESTRIAN
BRIDGE
ATHENS, GREECE
4 Panoramic Elevators

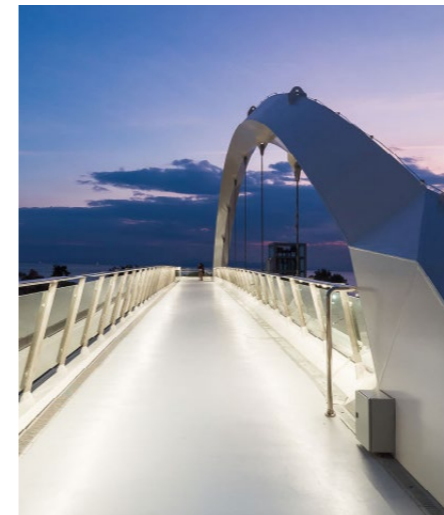



HOTEL
THESSALONIKI, GREECE

- 1 Panoramic Elevator
- 1 Hydraulic Elevator
- 1 Custom Elevator



H&M STORES
SERBIA
MRL Panoramic
2000 kg



MAKEDONIA PALACE
THESSALONIKI, GREECE

4 Elevators
10 Stops
4-Plex with destination control

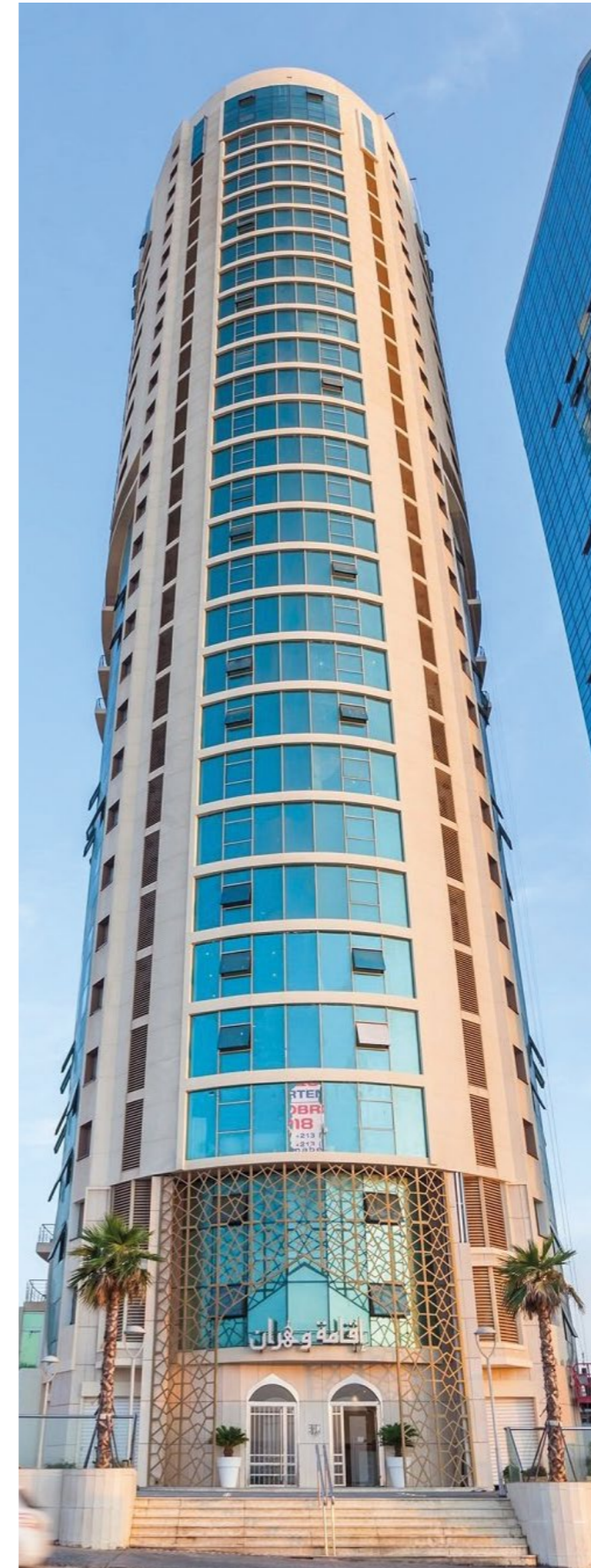

LUXURY RESIDENTIAL
BUILDING

ORAN, ALGERIA

4 Car Lifts
4000 kg
17 m. underground

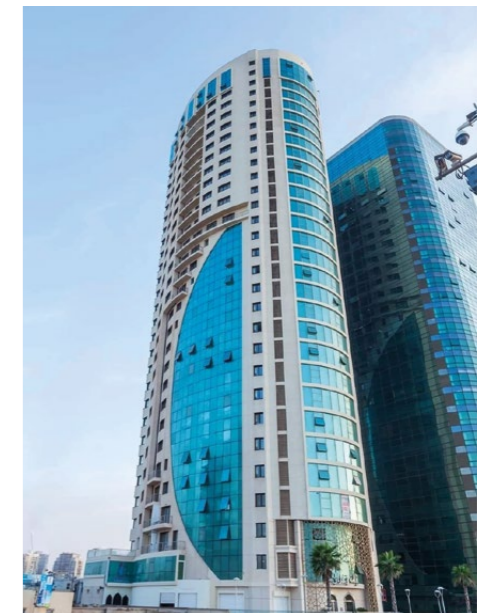

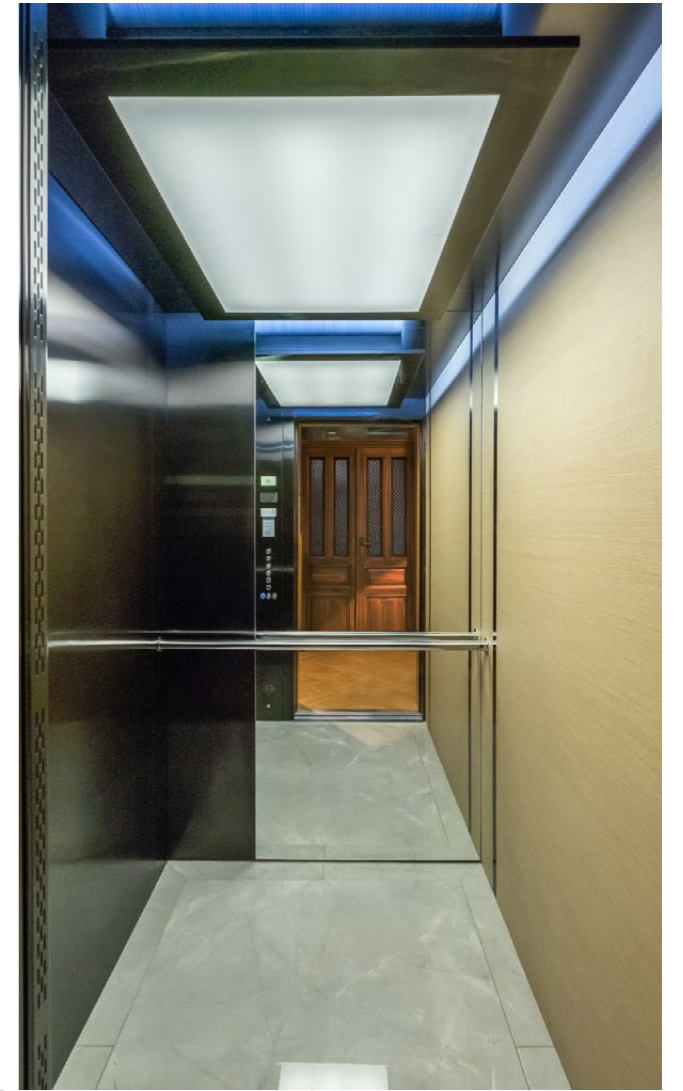

PRIMARY PUBLIC
SCHOOL
JASTRZEBIE ZDROJ, POLAND
4 Stops
800 kg



HISTORICAL OFFICES
BUILDING
THESSALONIKI, GREECE
MRL Elevator
6 Stops

STADIUM
SYDNEY, AUSTRALIA
MRL Low Pit & Low Headroom
1000 kg



LUXURY PRIVATE
HOME
LONDON, UNITED KINGDOM
MRL Elevator
630 kg



WEELEVATEMOMENTS

GRAPHIC DESIGN & ART DIRECTION:

EKTOR.DESIGN

Copyright © 2021 by WYLTOR.

Όλα τα δικαιώματα διατηρούνται. Κανένα τμήμα αυτού του εντύπου δεν μπορεί να αναπαραχθεί, να διανεμηθεί ή να μεταδοθεί με οποιαδήποτε μορφή ή με οποιονδήποτε τρόπο, συμπεριλαμβανομένης της φωτοαντιγραφής, χωρίς την έγγραφη άδεια του εκδότη, εκτός από τις περιπτώσεις σύντομων εισαγωγικών σε κριτικές και σε ορισμένες άλλες μη εμπορικές χρήσεις που επιτρέπονται από το νόμο περί πνευματικών δικαιωμάτων.

Οι εικόνες στο παρόν έντυπο ενδέχεται να διαφέρουν από την πραγματικότητα. Η εταιρία διατηρεί το δικαίωμα μετατροπής οποιουδήποτε μοντέλου και προδιαγραφών χωρίς προηγούμενη ειδοποίηση.

All rights reserved. No part of this publication may be reproduced, distributed, or transmitted in any form or by any means, including photocopying, recording, or other electronic or mechanical methods, without the prior written permission of the publisher, except in the case of brief quotations embodied in critical reviews and certain other noncommercial uses permitted by copyright law.

The illustrations in this publication may differ from the reality. The company reserves the right to convert any model and specification without prior notice.



THESSALONIKIS POLYGYROU RD,18 KLM
THERMI ZIP CODE 57001
THESSALONIKI
GREECE

+30 2310 463212
+30 2310 463811
FAX: +30 2310 463406
info@wyltor.com

WE REPLY IN 24 HRS
wyltor.com